



FLX FLOORLINE BED

USER MANUAL



Thank you for choosing the
Aidacare FLX Floorline Bed.

This bed has been specifically designed to offer
comfort, support and safety.

**It is important that you read this user manual
carefully before using your new bed.**



This product features the CE mark, in compliance with the Medical Devices Regulation 2002 (as amended) Class 1, and the Medical Device Regulation 2017/745.



This product Features the UKCA mark, in compliance with Part II UK MDR 2002 (as amended) Class 1.

© Aidacare Pty Ltd 2024

No part of this user manual may be copied, distributed, reproduced, scanned or stored on any electronic database, whether in whole or in part in any form or by any means.

Due care has been taken to ensure all the information contained in this user manual is correct at the time of printing. All measurements, pictures, colours and weight capacities are to be used as a guide only. We reserve the right to modify the design or appearance of any product displayed in this user manual without prior notice.

TABLE OF CONTENTS

1. Symbols Used In This Manual	4
2. Symbols Used On The Product	5
3. Introduction	6
4. Safety Precautions	7
5. Overview	9
6. Specifications	10
7. Accessories	11
8. Electronic Functions	13
9. Assembly	17
10. General Operation	38
11. Storage & Movement	40
12. Cleaning	41
13. Maintenance	42
14. Troubleshooting	43
15. Warranty & service	44
16. Recycling Instruction	45
17. Manufacturer, EU Representative & Importer Details	46
18. Service Log Book	47

1. SYMBOLS USED IN THIS MANUAL

The symbols below are used throughout this owner's manual and on the product to identify warnings and important information. It is very important for you to read them and understand them completely.



Indicates a potentially hazardous condition/situation. Failure to follow designated procedures can cause either personal injury, component damage or malfunction. On the product, this icon is represented as a black symbol on a white triangle with a black border.



ALWAYS! These actions should be performed as specified. Failure to perform mandatory actions can cause personal injury and/or equipment damage. On the product, this icon is represented as a white infinity symbol on a black dot with a white border.



DO NOT! These actions are prohibited. These actions should not be performed at any time or in any circumstances. Performing a prohibited action can cause personal injury and/or equipment damage. On the product, this icon is represented as a white symbol with a black circle and black slash.

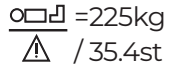

MAXIMUM PATIENT WEIGHT. This weight represents the total maximum weight of a patient on the bed. This weight (225kg / 35.4st) should not be exceeded at any time.

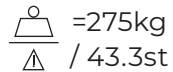

SAFE WORKING LOAD (SWL). This weight represents the total maximum weight that the bed can carry, including patient, mattress, bedding, bed ends and accessories. This weight (275kg / 43.3st) should not be exceeded at any time.



Please scan the QR code or visit our website aidacare.com.au and search 'Aidacare FLX (BEB048600 or BEB048610)' to access product marketing and technical documentation.

2. SYMBOLS USED ON THE PRODUCT



Please note: Sticker is sample only and not to scale

- | | |
|--|------------------------------|
| Product Code | CE Mark |
| Serial Number | Read User Manual |
| Manufacturer | Caution |
| Importer | Medical Device |
| Authorised Representative in EU | Safe Working Load |
| Country of Manufacture | Maximum Patient Weight |
| UKCA Mark | Type B as per IEC60601-1 |
| Includes Electronics components and should be mixed with General household waste | Class 2 Electrical Equipment |





3. INTRODUCTION

The Aidacare FLX Bed is an electrically operated Floorline Bed offering functions and positional movements that assist caregivers and maximise patient comfort and safety. Ease of use, functionality, serviceability and cleaning practicality are key features of the bed. The bed has a welded steel structure with an anti corrosion treatment layer underlying the durable powder coated finish. The plastic components are made from urethane, PP and POM nylon and ABS plastic.

CLINICAL APPLICATIONS AND AREA OF USE

This bed is appropriate for adult patient care and should only be used under the instruction of a carer or health professional where concerns exist around patient safe use.

KEY FEATURES

 =275kg Maximum safe working load (SWL) of the bed is 275kg /
 / 43.3st 43.3st with a suggested maximum user weight of 225kg
/ 35.4st which conservatively takes into account common
 =225kg accessories used with care beds such as alternating pressure
 / 35.4st mattresses, assist bars and foam mattresses

- **ExitSafe** single button ingress / exit height
- **SmartDescent** automatically slows lowering speed from 300mm / 11.8" above floor level to lowest position. Designed to improve resident and carer safety whilst reducing potential for damage to equipment such as air mattress pumps becoming trapped under the bed
- Electrically adjusted height range from 105 – 750mm / 4" – 29.5"
- 75mm / 3" twin castors with single activation locking mechanism for ease of use
- Four section electrically operated mattress platform
- with independent adjustment of backrest angle (maximum 62°) and knee section angle (maximum 40°)
- Bi-lateral mattress retainers with length adjustable mattress extension retainer at foot end
- Integrated foot end extension extends the bed by 100mm / 4" or 200mm / 7.9"
- Large range of feature enhancing accessories
- Removable bed ends
- Auto-regression integrated into backrest reduces sacral pressure, shear forces and abdominal compression during bed profiling

4. SAFETY PRECAUTIONS

This User Manual outlines the intended use of the Aidacare FLX Bed, the intended use constitutes how to achieve full functionality whilst maximising safety and efficiency for care staff and patients alike.

It is **important** that this User Manual is read in its entirety prior to operating the bed. The manual is designed to ensure that users are equipped with the information required to competently and responsibly operate the bed and its accessories.

It is recommended that the User Manual be kept in an easily accessible place for quick reference. If required, Aidacare product specialists can provide additional training.

All warnings and cautions within this manual should be strictly adhered to. Failure to do so could result in harm to the patient or operator.

Warnings highlighted throughout this manual identify possible hazards in procedures or conditions which if not followed correctly could result in serious injury, or fatality.

Cautions highlighted throughout this manual identify possible hazards in procedures or conditions, which if not followed correctly could result in equipment damage, or failure.













GENERAL

- Electrical equipment can be hazardous if used incorrectly
- Residual current devices (RCD) are not supplied with FLX Beds. Please consult with your Biomedical Engineer/advisor concerning RCD requirements
- The clinically qualified person responsible should consider the age, size and condition of the patient before using the bed and its accessories
- The maximum safe working load of the FLX Bed is 275kg / 43.3st and includes the mass of the patient, mattress and any accessories fitted to the bed
- The maximum suggested standard mattress thickness for use with the FLX Bed is 150mm / 6" (foam mattresses) and 200mm / 7.9" (alternating mattress replacements)
- The bed should only be used with approved accessories. Contact Aidacare for a full list of approved accessories
- If a patient's condition could lead to a possible entrapment the mattress support platform should be left in the flat position whilst unattended
- To ensure safe functioning of the bed electronics, the electronic system must be reset when any changes are made to it. Changes are defined as:
 - Mains power is lost (power outage, turned off/on, mains cable is unplugged)
 - Component cabling is disconnected from or connected to the control box or junction box

Refer to section 7.4 to complete the electronic system reset

5. OVERVIEW

The Aidacare FLX Bed has been designed specifically for the aged care environment. Please take the time to familiarise yourself with the key components shown below:

-  **ALWAYS** position the bed at its lowest height when unattended by caregivers to minimise the risk of patient injury from falls when getting in and out of the bed.
-  **ALWAYS** use the **ExitSafe** Button whenever the patient is entering or exiting the bed to ensure transfers are completed at a safe height to minimize falls risk.
-  **ALWAYS** use a mattress of appropriate size and type. A range of suitable pressure reducing and pressure relieving mattresses are also available from Aidacare.
-  **ALWAYS** make sure that the patient is safely positioned to avoid entrapment before operating the bed.
-  **ALWAYS** ensure that attendant and patient limbs are free from potential entrapment areas before operating any functions.
-  **ALWAYS** use the **ExitSafe** Button when treating a patient or transporting the bed to avoid unnecessary bending/stooping by care staff.
-  **ALWAYS** apply the brakes when the bed is stationary.
-  **ALWAYS** store the handset when not in use to avoid accidental operation of the beds functions. The handset can be stored by hooking it on to the side rail of the bed or positioning it in the handset holder bracket (additional accessory).
-  **ALWAYS** ensure that all drips and drains (hospital lines) and power cables are free from possible entanglement with mechanical parts of the bed.
-  **DO NOT** place the handset, or power cord across the mattress surface of the bed when the bed is not connected to mains power. Always store the power cord using the fastening straps provided.
-  **DO NOT** use electrically operated beds in the presence of flammable gases.
-  **DO NOT** use the bed to support more than one patient. FLX Beds are intended for single person use and may become unstable if used incorrectly. Usage outside of intended design will void all warranties associated with this product.
-  **DO NOT** use accessories that are not designed, or approved for use with FLX Beds.

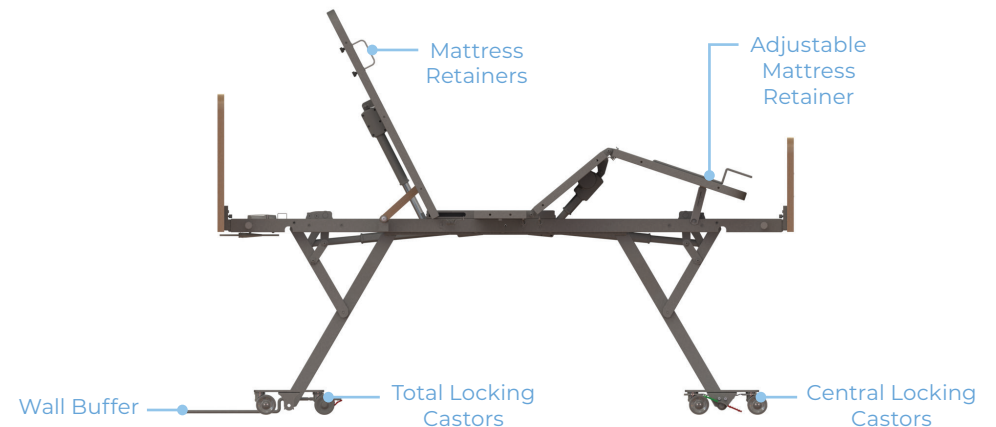
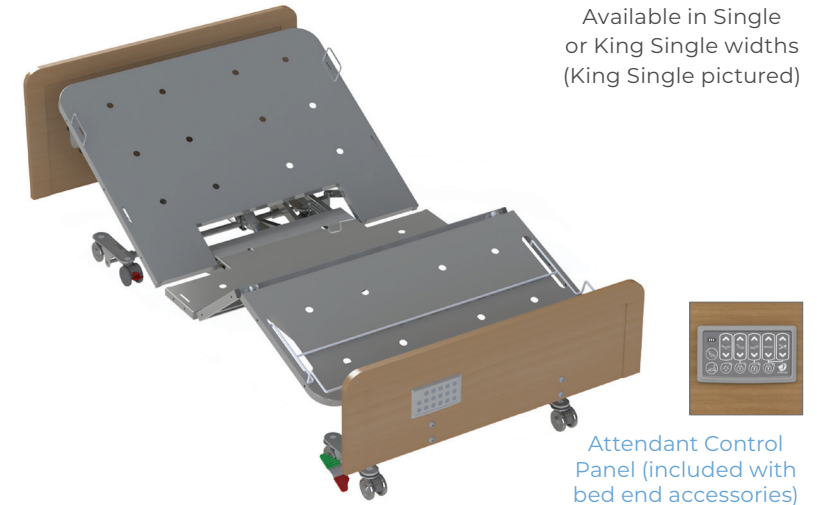

6. SPECIFICATIONS

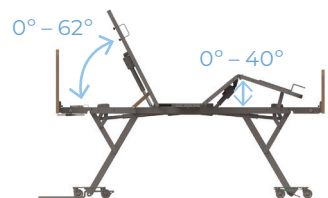

NOTE: Backrest and knee bend angle is the same across both Single and King Single beds

Dimensions

	Overall Length	Overall Width	Overall Height	SWL
Single:	2130–2330mm 83.9"–91.7"	964mm 40"	105–750mm 4"–29.5"	275kg 43.3st
King Single:	2130–2330mm 83.9"–91.7"	1124mm 44.3"	105–750mm 4"–29.5"	275kg 43.3st

Mattress Size

MODEL	Single	King Single
Recommended Mattress Size	Width = 900mm / 35.4"	Width = 1060mm 41.7"
Maximum Mattress Depth	Length = 2000mm / 78.7"	
	Foam Mattress = 150mm / 6"	
	Alternating Air Replacement Mattress = 200mm / 7.9"	

Bed Weight & Safe Working Load

Bed Weight – Single	105kg / 231.5lbs
Bed Weight – King Single	115kg / 253.5lbs
SWL (Safety Factor 2 x SWL)	⚠️ 275kg / 43.3st
Max User Weight	⚠️ 225kg / 35.4st (makes allowance for accessories like mattresses, air mattresses and pumps, bed poles etc.)

Electrical Parameters

Power Input	240V AC 50Hz, Max current 4000mA
Rate Load	Interruption 10%, Max 2 minutes / 18 minutes
Leakage Protection	Class II Type B ⚡
Waterproof Grade	IP54









Standards Compliance

Aidacare FLX Beds are designed and manufactured where required in compliance with International Medical Device Safety standard IEC60601-1, IEC60601-2-52. All electronics are designed for use in Acute Care environments and comply with relevant Electrical Safety Standards.

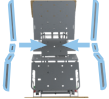
7. ACCESSORIES

A range of FLX Bed accessories are available. In addition to the below listed accessories, Aidacare specialises in other complimentary products such as foam mattresses, pressure care surfaces, over bed tables, side lockers and adjustable day chairs. Please contact Customer Service on 1300 133 120 for further information.

Code	Description	
BEB048700	Bed End Set – Single – Como – Teak	
BEB048710	Bed End Set – King Single – Como – Teak	
BEB048701	Bed End Set – Single – Como – Milano	
BEB048711	Bed End Set – King Single – Como – Milano	
BEB048785	Full Length Rails – Set of 4 – Teak	
BEB048790	Full Length Rails – Set of 4 – Walnut	
BEB048750	Bed End Set – Single – Como – Teak	
BEB048770	Bed End Set – King Single – Como – Teak	
BEB048755	Bed End Set – Single – Como – Milano	
BEB048775	Bed End Set – King Single – Como – Milano	
BEB046265	Bed Side Set – Sublime – Teak	
BEB046275	Bed Side Set – Milano – Walnut	

Code	Description	
BEA829140	Self Help Pole	
BEA829145	Mounting Bracket & Hardware – For Self Help Pole & IV Pole	
BEA029710	IV Pole	
GSP390370	Mounting Bracket & Hardware – IV Pole Only	
BEB046505	Width Extension Kit	
BEB046525	Split Folding Grab Rails (Pair)	
BEB046592	Battery Backup	
BEB046616	USB Port Upgrade Kit	
BEB046630	Directional Castor (Replaces Total Locking Castor at Head End)	
BEA030030	Handset Holder	



Do not use accessories that have not been designed for use with FLX Beds.

8. ELECTRONIC FUNCTIONS



- Ensure the patient, caregivers and/or equipment is positioned to avoid being trapped or crushed during bed adjustment
- Ensure the power lead is not stretched excessively
- Ensure the handset and electrical leads cannot become entangled with moving parts of the bed
- **DISCONNECT** the power lead from the mains and stow before transporting the bed
- If the power lead shows any sign of damage, replace immediately
- Ensure safety key is removed when handset is not in use

8.1 HANDSET OPERATION

FLX Beds are powered by four electric rated actuators, which are controlled by the Handset or Attendant Control Panel. Adjustment occurs only while a button is pressed. Adjustment will stop when the button is released, or the selection reaches the end of its range.

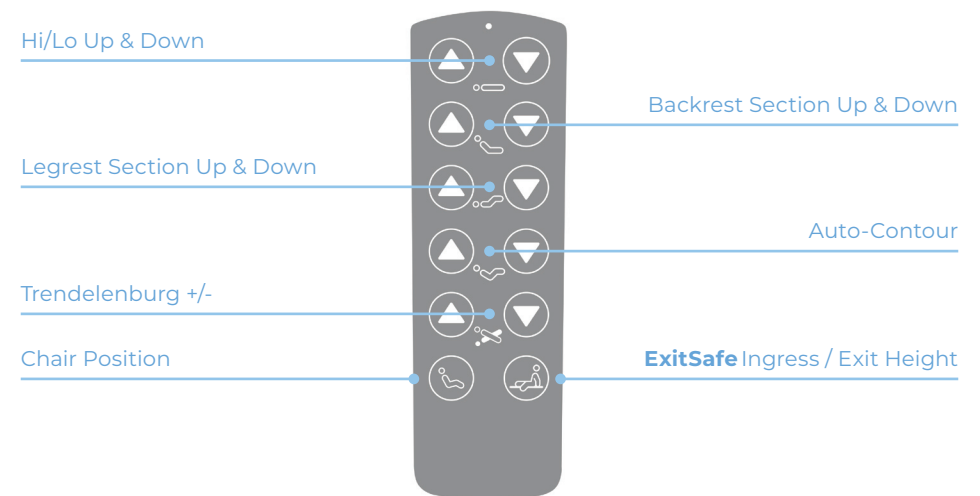

8.2 ATTENDANT CONTROL PANEL (ACP) OPERATION

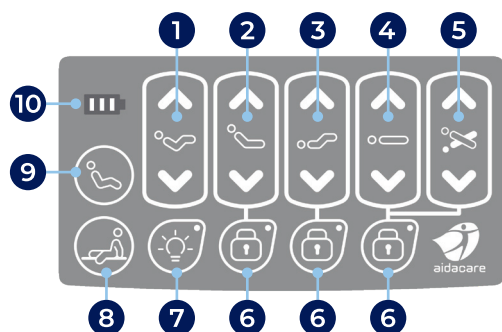

- 1 Auto-Contour:** Conveniently positions patient into cardiac chair position for therapeutic benefit and assists in preventing skin shear/patient sliding down the bed when raising backrest
- 2 Backrest Section:** Controls the backrest angle from horizontal up to a maximum of 62°
- 3 Knee Break Section:** Allows for knee positioning up to 40° for increased user comfort and pressure therapy relief. The ratchet legrest can also be enabled by hand to further increase comfort
- 4 Hi/lo with SmartDescent:** Positions the bed to the desired height from 105-750mm / 4"-29.5". The bed automatically halves its rate of descent from 300mm / 11.8" to lowest position to minimise the risk of entrapment or damage to low lying items such as mattress pumps
- 5 Trendelenburg +/- :** Facilitates overall +ve or -ve tilting of the bed from -12° to 12° from horizontal
- 6 Patient Lock Out:** Locks handset out of specific function
- 7 Underbed Light:** Creates a subtle glow on the floor near the bed end for carers and users during the night

- 8 ExitSafe Ingress / Exit Height:** Flattens the mattress surface and then raises the bed to the optimal height for entry/exit from the bed. This height is ideal for manutention/manual handling by carers and also facilitates CPR if required.

To adjust the exit height for the user raise or lower bed to desired height then simultaneously press ExitSafe Ingress/ Exit Height and Trendelenburg Down buttons for 5 seconds. Handset top LED will blink indicating the new height has been written to memory. The new ExitSafe height is now ready to use.
- 9 Chair Position:** Raises backrest and legrest into cardiac chair orientation and then tilts bed forward into an upright dining position
- 10 Battery Power Indicator:** Illuminates on start-up, but thereafter only if optional battery backup is installed



Care should be taken whilst operating the bed functions to ensure hands and fingers are free from potential squeeze hazards

9. ASSEMBLY

8.3 INSTALLING THE HAND CONTROL

The FLX bed handset mounts into a receiver in the middle of the bed, allowing for it to be used from either side of the bed.

Once handset is mounted into receiver, choose which side of the bed the handset is to be used on and mount the cable to the mounting clip located either side of the bed

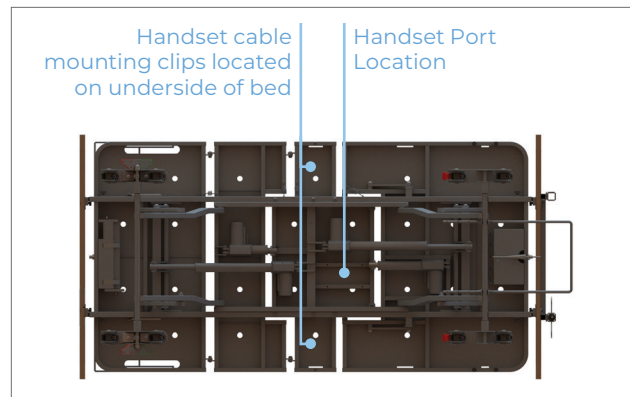

8.4 RESETTING THE ELECTRONIC SYSTEM

To ensure safe functioning of the bed electronics, the electronic system must be reset when any changes are made to it.

Changes are defined as:

- Mains power is lost (power outage, turned off/on, mains cable is unplugged)
- Component cabling is disconnected from or connected to the control box or junction box

To complete the reset procedure, simultaneously press hi-lo up and hi-lo down buttons for 5 seconds. Continue pressing while the bed moves on its own (and calibrating the system) until the bed stops moving and the handset top LED flashes 3 times. The electronic system is now reset.

9.1 FLX BED ASSEMBLY

The FLX Bed comes securely packaged in a cardboard carton. The outside of the carton is protected by corner and centre stabilisers for rigidity to avoid compression and damage in shipping. The FLX Bed should arrive to you in pristine condition, ready for immediate assembly and installation.

Contents:

- 1 x FLX Bed
 - 1 x Set of 2 x Mattress retainers and hardware
 - 1 x Adjustable mattress retainer
 - 1 x Wall buffer
 - 1 x Handset (located under the backrest)
 - 1 x Set of 2 x head and footboard holders
 - 1 x Set of 2 x long footboard holders (attached to frame under leg section)
- NOTE:** head and footboards sold separately.



The FLX Bed is a large piece of advanced medical equipment requiring special attention and careful handling at all times.

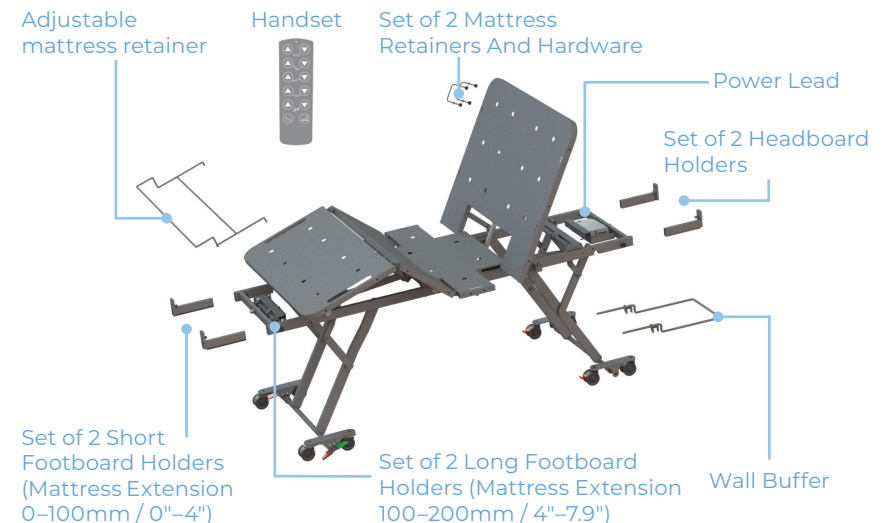

Depending on the situation, appropriate powered or manual lifting, handling or moving assistance equipment includes but is not limited to:

- Forklift
- Walkie Stacker
- Hydraulic Pallet Jack
- Hydraulic Lift Trolley
- Goods Trolley
- Tail Gate Loader

 **Always** use appropriate manual and powered handling techniques and equipment.

 **ALWAYS** be aware of sharp items in packaging materials, handle and dispose or recycle appropriately.

 **Always** wear appropriate protective clothing and eye goggles.

 **Always** use cut-proof gloves when handling or cutting steel or plastic carton strapping.

 **Do not** attempt to lift an FLX Bed manually without appropriate equipment.

9.2 FLX BED ASSEMBLY

A. Unpack Bed, Plug In, Raise and Move:

1. Using appropriate equipment lower the bed carton onto a hard flat surface
2. Carefully remove strapping and external dunnage materials, remove the carton lid and remove internal dunnage materials
3. Locate all component packets as per carton contents
4. Flatten the sides of the carton base
5. Plug in Power Lead. To locate it, lift up the mattress platform head section. Undo zip tie to release the power lead
6. Ensure the bed is free of encumbrance or obstacles – press the hi/lo up button on the handset and raise the bed to an appropriate height (600–700mm / 23.6"–27.6" recommended) so as to fit Mattress Retainers, Head & Foot Board Holders and Wall Buffer
7. Unlock central locking brake at the foot end by pressing the green pedal and unlock the locking castors at the head end by lifting the locking tab
8. Roll the bed out of the flattened carton and position or move the bed as desired
9. Remove remaining dunnage and wrapping and other materials such as protective foam and zip ties

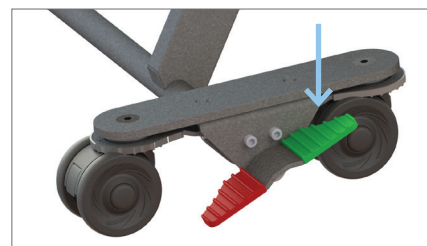

B. Mount Mattress Retainers (Backrest End):

1. Unpack the set of Mattress Retainers and hardware
2. Insert vertically through holes on the Mattress Platform sides. Fasten firmly with hand from beneath

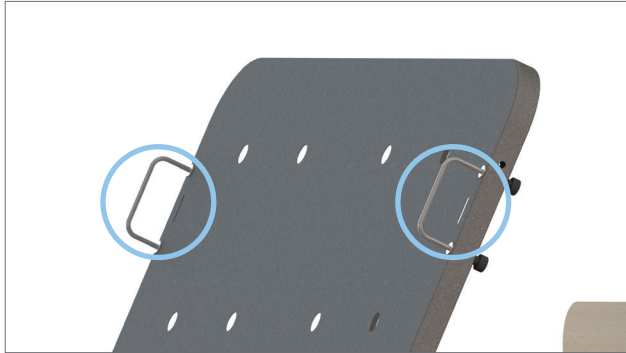

C. Mount Adjustable Mattress Retainer (Foot End)

1. Unpack the Adjustable Mattress Retainer
2. Insert mattress retainer ends into 1 of the 3 receiving holes which are 100mm / 4" spaced at the foot end of the mattress platform to match the desired bed extension (nil, 100mm / 4", 200mm / 7.9"). Insertion may require lightly squeezing the retainer to fit. Lower the retainer to the mattress platform

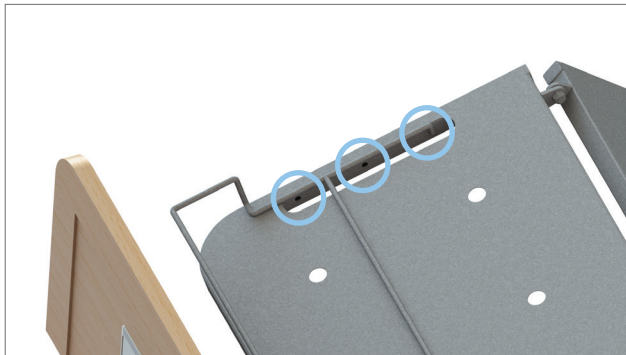

D. Mount Head and Footboard Holders:

1. Unpack the Head and Footboard Holders
2. Loosen handwheel bolts located on the frame at the head and foot ends of the bed (4 positions)
3. Slide the holders into the frame at the head and foot ends, ensuring that the plates face towards each other

NOTE:

- a. If a mattress extension length of 0 or 100mm / 4" is desired, use the holders from the box
 - b. If a mattress extension length of 100–200mm / 4"–7.9" is desired, use the longer holders located under the legrest and ensure the shorter holders are placed under the legrest for future use
4. Slide the holders fully at the head end
 5. Slide the holders to desired mattress extension length at the foot end
 6. Tighten handwheel bolts to lock position

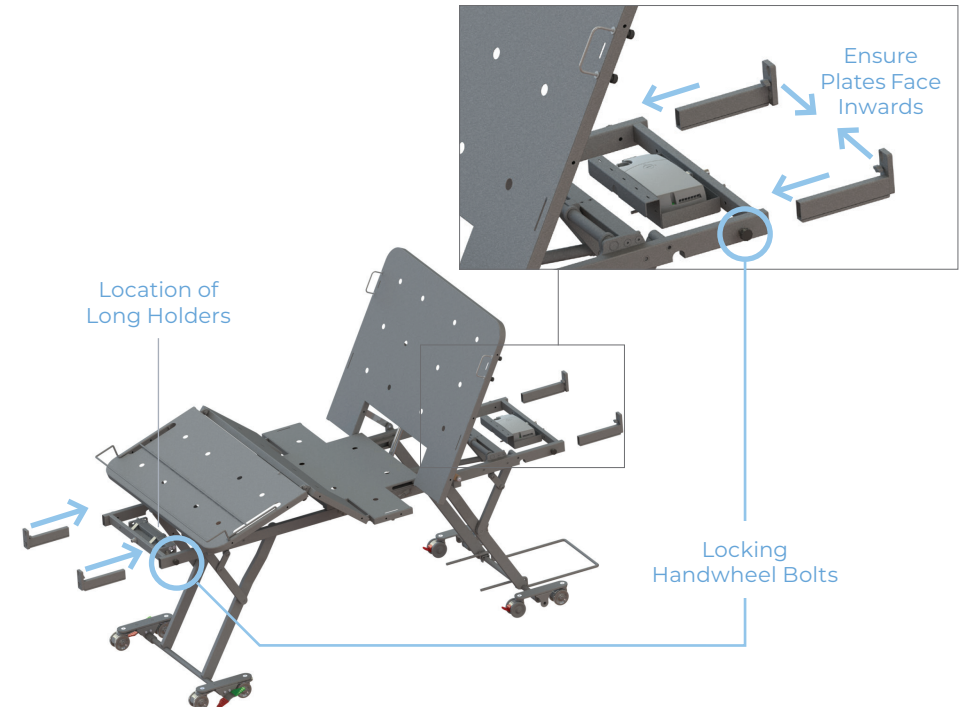

E. Mount and Adjust the Wall Buffer

1. Unpack the Wall Buffer
2. To fix onto frame, simply click buffer's U-brackets to the rear axle of the frame. Press firmly to ensure buffer is firmly held in place
3. Adjust the length of the wall buffer by pulling the locking pins out, sliding the buffer to desired position and locking again with the two pins

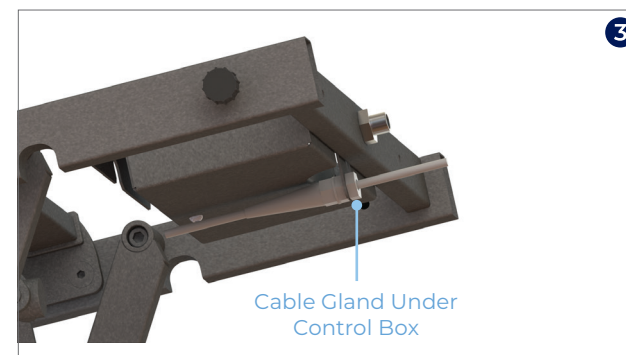
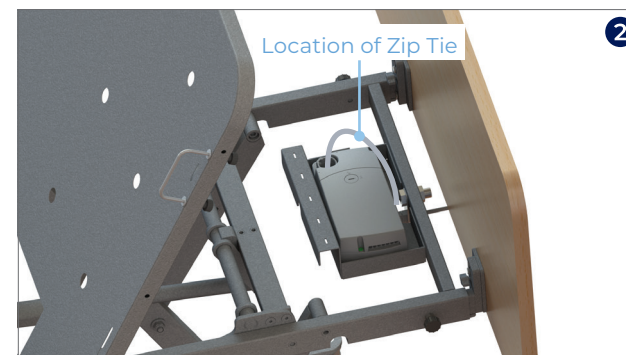
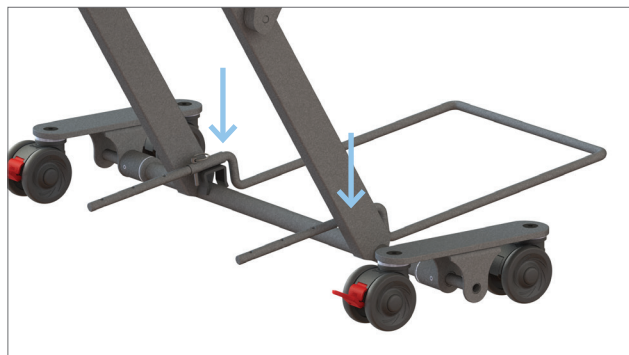

F. Adjust Length of Power Lead

The power lead length out of the bed can be extended by 200mm / 7.9" to allow it to reach power outlets further away from the bed.



WARNING

DO NOT extend the power lead unnecessarily as this may allow the power lead to curl back under the bed and get caught in the bed mechanism. Care must be taken to ensure this is not possible prior to using the bed and after every subsequent bed relocation.

To extend the power lead:

1. Raise the backrest to maximum height
2. Locate and cut the zip tie holding the power lead's excess cable to the frame
3. Loosen the cable gland holding the power lead to frame
4. Pull power lead through cable gland to desired length
5. Tighten cable gland to hold power lead in place
6. Test bed through both its hi-lo and backrest movement range and ensure the power lead does not get pinched or crushed by the frame. Any excess and loose power cord remaining between the cable gland and control box must be secured to the frame to prevent unintentional movement

G. Position the bed:

You may position the bed as desired however it is recommended that if the head end is positioned against a wall, the wall buffer should be in contact with both the floor and wall or skirting board.

1. If necessary, gather and fasten excess ACP or power leads away from encumbrance with moving parts

9.3 HEAD AND FOOT BOARD ASSEMBLY (SOLD SEPARATELY)

The Head and Foot Board attachment system is designed to allow quick and secure fitting of Head and Foot Board options as well as customised options to suit any interior design specifications

Carton Contents (size and colour is SKU dependent):

- 1 x Headboard with mounting brackets pre-fitted
- 1 x Footboard with mounting brackets pre-fitted and with or without attendant control panel pre-fitted



Assembly of Head and Footboards:

1. Locate head and footboard holders on the frame (see section 8.1)
2. Untighten the handwheel bolt locking the holders in place
3. Loosen the thumb screws on the board holders
4. Bring the head board up towards the headboard holders
5. Align the pins on the headboard with the receiver holes in the holders. Insert pins and press down on board so that the pins drop into the keyhole. Ensure all four pins are located in the keyholes
6. Tighten thumb screws to lock headboard in place
7. Slide headboard all the way in
8. Repeat steps 4-6 with the footboard
9. Slide footboard to desired mattress extension length
10. Tighten 4 x handwheel bolts to lock board holders in place
11. Plug ACP lead to ACP port located under the legrest of the bed
12. Gather and zip tie excess ACP lead to frame if required

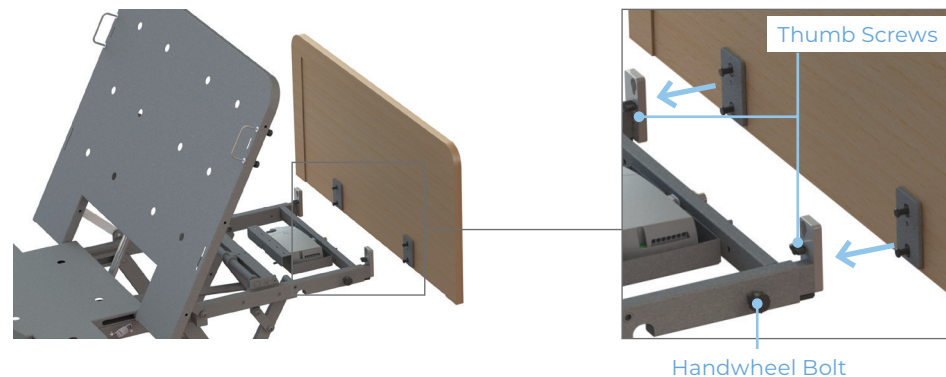

9.4 SIDE PANEL ASSEMBLY (SOLD SEPARATELY)

The FLX Side Panels are designed to match the FLX Head and Foot Board options for a complete surround finish. They can also be customised to match customised Head & Foot Boards to suit any interior design specifications.

The FLX Side Panels are designed to move independently with each bed platform section they are attached to.

Contents (colour is SKU dependent):

- 1 x HEAD section LEFT (longest) – unique to this section and side
- 1 x HEAD section RIGHT (longest) – unique to this section and side
- 2 x MID section LEFT/RIGHT (shortest) – fits left/right side of this section
- 2 x KNEE section LEFT/RIGHT (second shortest) – fits left/right side of this section
- 1 x FOOT section LEFT (second longest) – unique to this section and side
- 1 x FOOT section RIGHT (second longest) – unique to this section and side
- 18 x Bolts

Assembly of Side Panels:

1. Remove any accessories attached to the side of the bed frame (e.g. rails)
2. Ensure the panels are matched to the correct platform section and left/right side as per the list above – some are unique to SECTION AND LEFT/RIGHT side
3. Place the panel on the matching platform section. The top of the panel should be flush with the top of the mattress platform
4. Line up the panel nutserts with the holes in the bed frame
5. Insert the bolt through the hole and screw into panel nutsert
6. Fasten firmly
7. Repeat for all panels – check to ensure all are correctly attached upon completion

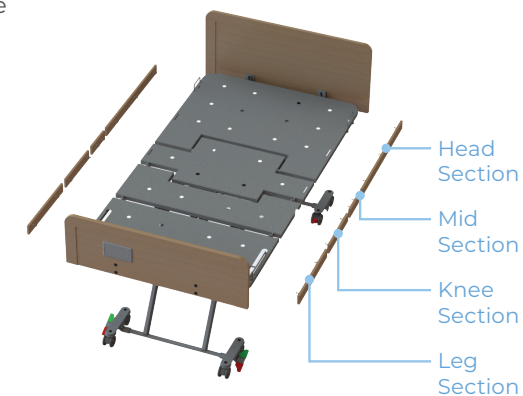

9.5 SELF HELP AND IV POLE MOUNTING BRACKET ASSEMBLY (SOLD SEPARATELY)

The self help and IV Pole mounting bracket provides a secure and strong location to mount a self help-pole (BEA829140) and IV pole (BEA029710) onto the bed.

Contents:

- 1 x Self Help Pole Mounting Bracket
- 4 x Bolts

Assembly of Mounting Bracket:

1. Remove headboard from bed
2. Undo the bolts that hold the plate onto the headboard
3. Place the mounting bracket on one side of the headboard and the original plates on the opposite side. Affix the mounting bracket and plates using the provided bolts and tighten
4. Mount the headboard back onto the bed (see section 8.3) and lock in position

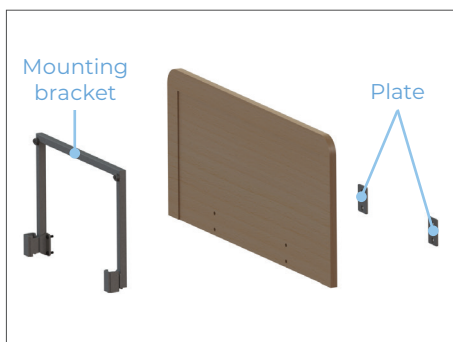

9.6 SELF HELP POLE ASSEMBLY (SOLD SEPARATELY)

The Self Help Pole (SHP) provides an overhead patient support or manoeuvring handle to assist with repositioning.

The Self Help Pole is designed to attach to the Aidacare AC4 and FLX Beds. However, while the AC4 bed already has receiver tubes attached to the bed frame, the FLX bed requires assembly of Mounting Bracket & Hardware Kit (GSP390360) before the Self Help Pole can be mounted.



Be aware of encumbrances such as walls, cupboards, curtains, lights etc. when manoeuvring the bed with a Self Help Pole. Pay particular attention when tilting the bed or using the Trendelenburg or reverse Trendelenburg functions (where available).



Self Help Pole Safe Working Load is 75kg / 11.8st only.

DO NOT exceed this load at any time.

Contents:

- 1 x Self Help Pole

Assembly of Self Help Pole:

1. If assembling onto Aidacare FLX or FL250 beds: ensure the Self Help and IV Pole Mounting Bracket (GSP390360) is assembled onto bed prior to fitting the Self Help Pole
2. Slide the Self Help Pole into the receiver brackets on the Self Help and IV Pole Mounting Bracket. Push down to ensure correct fitment



9.7 IV POLE ASSEMBLY (SOLD SEPARATELY)

The IV Pole provides a telescoping height adjustable hanger for tubes, bags and other equipment.

The IV Pole is designed to attach to the Aidacare AC4 and FLX Beds. However, while the AC4 bed already has receiver tubes attached to the bed frame, the FLX bed requires assembly of Mounting Bracket & Hardware Kit (GSP390360) before the Self Help Pole can be mounted.



Be aware of encumbrances such as walls, cupboards, curtains, lights etc. when manoeuvring the bed with a IV Pole. Pay particular attention when tilting the bed or using the Trendelenburg or reverse Trendelenburg functions (where available).



Self Help Pole Safe Working Load is 10kg / 1.5st only.
DO NOT exceed this load at any time

Contents:

- 1 x IV Pole
- 1 x nylock nut
- 1 x washer
- 1 x square block

Assembly of Self Help Pole:

1. If assembling onto Aidacare FLX or FL250 beds: ensure the Self Help and IV Pole Mounting Bracket (GSP390360) is assembled onto bed prior to fitting the IV Pole
2. Undo the nylock nut and washer at the bottom of the pole and remove the square block
3. Slide the IV Pole into the receiver brackets on the Self Help and IV Pole Mounting Bracket on the bed. Push down to ensure correct fitment
4. Mount the square block followed by washer and nylock nut from underneath the bracket and lock in place

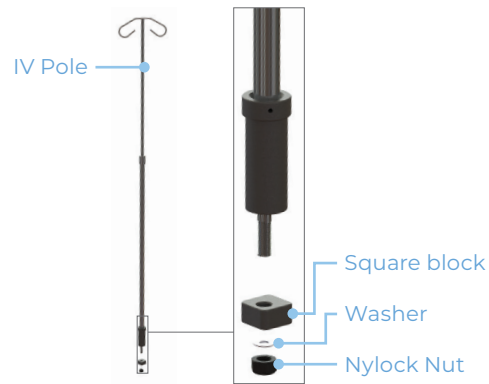

9.8 KING SINGLE CONVERSION KIT ASSEMBLY (SOLD SEPARATELY)

The FLX King Single Conversion Kit is designed to retrofit a Single FLX bed into a King Single. This kit should not be used to extend the width of a King Single bed.

King Single FLX beds are available separately (BEB048610).

Each kit section attaches to a platform section of the bed, increasing the bed width from 900mm / 35.4" (Single) to 1060mm / 41.7" (King Single).

Carton Contents:

- 1 x HEAD section LEFT (longest) – unique to this section and side
- 1 x HEAD section RIGHT (longest) – unique to this section and side
- 2 x MID section LEFT/RIGHT (shortest) – fits left/right side of this section
- 2 x KNEE section LEFT/RIGHT (second shortest) – fits left/right side of this section
- 1 x FOOT section LEFT (second longest) – unique to this section and side
- 1 x FOOT section RIGHT (second longest) – unique to this section and side
- 18 x Bolts & washers

Assembly of King Single Conversion Kit:

1. Remove any accessories attached to the side of the bed frame (e.g. rails or side panels)
2. Ensure the panels are matched to the correct platform section and left/right side as per the list above – some are unique to SECTION AND LEFT/RIGHT side
3. Line up the panel holes with the holes in the bed frame
4. Insert the washer onto the bolt
5. Insert the bolt through the hole and screw into panel weldnut
6. Fasten firmly
7. Repeat for all panels – check to ensure all are correctly attached upon completion

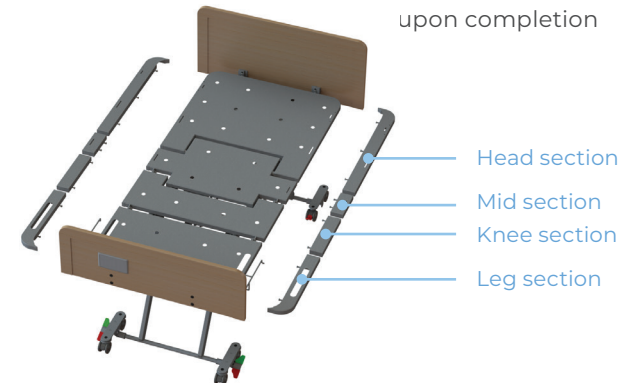

9.9 SPLIT FOLDING GRAB RAILS ASSEMBLY

The Split Folding Grab Rails are designed to provide self-support and assistance for positioning and movement within the bed.

The Split Folding Grab Rails are supplied as a left/right pair and require installation on the bed.

Carton Contents:

2 piece set includes:

- 1 x Split Folding Grab Rail with mounting plate – LEFT. 3 x bolts, bushes and dome nuts on mounting plate
- 1 x Split Folding Grab Rail with mounting plate – RIGHT. 3 x bolts, bushes and dome nuts on mounting plate

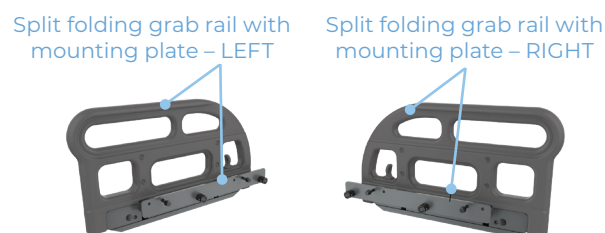

NOTE: If side panels are already fitted to the bed, they must be removed before the folding assist rail can be attached. They need to be removed from the entire bed or just the panel where the folding assist rail is wanting to be attached.

Recommended Tools:

- Power Drill
- Right Angled Power Drill Adaptor

Fastening Split Folding Grab Rails to Bed

1. Lift the bed, the backrest and legrest to maximum height for ease of assembly
2. The Split Folding Grab Rail is attached to the Head Section of the bed
3. The tapered end of the Split Folding Grab Rails with the release switch faces towards the foot end of the bed, as shown
4. Remove the 3 x bolts, bushes and dome nuts from the mounting plate
5. Place the mounting plate onto the bed frame (Head Section) and line up the bolt holes with the bed frame hole

6. Insert the bolts and fasten dome nuts on inside of bed frame
7. Fasten firmly – use a right angle power drill adaptor for easier access to the dome nut, apply high torque
8. Press the release lever within the rail to release and fold down gently. When the base of the rail is parallel to and alongside the bed frame it will stop in this position
9. To raise the rail, release the lever and pull it up by hand until it clicks into the up position

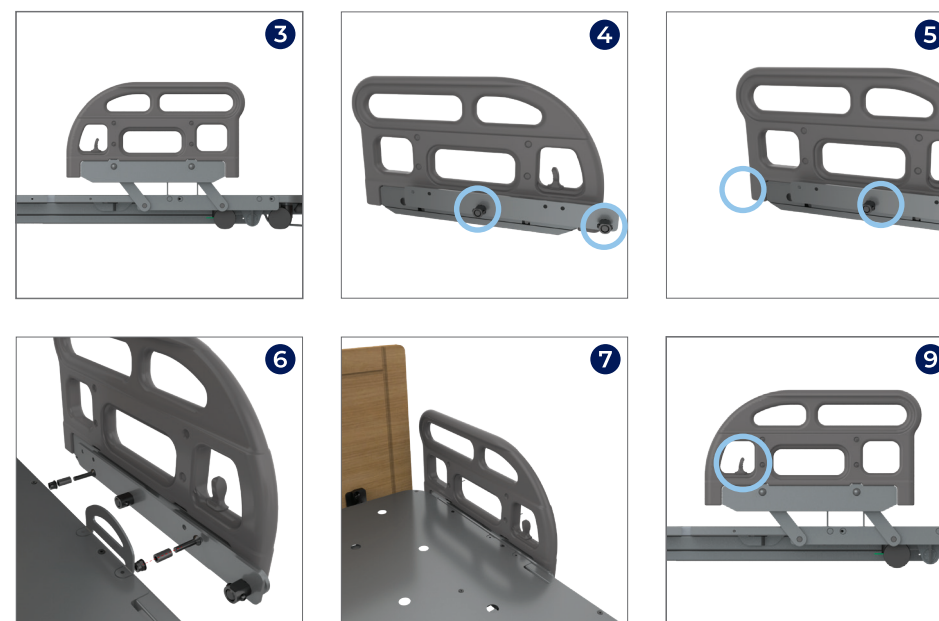

9.10 BATTERY BACK UP INSTALLATION



If fitted with a battery back-up unit the bed will automatically switch to battery power in the event of a power failure, or the bed being unplugged from mains power.

A fully powered new Battery Back-up may last 15 full lift cycles however this is dependent on user weight, movement range and battery age.

The Battery Back Up accessory is designed to provide back-up power in the event of a power outage or other event necessitating temporary use of the bed without access to a power outlet.

Carton Contents:

- 1 x Battery Backup
- 1 x hardware set

Assembly of Battery Backup:

1. Raise bed height and backrest to maximum height
2. Attach battery backup underneath the bed (in the middle, next to the head end hi-lo actuator)
3. Run the lead towards the control box at the head end of the bed
4. Disconnect beds' power lead from power source and wait 10 seconds for power to deplete from system
5. Use a flat head screw driver to turn the locking tab on the control box to unlocked position then slide the cover off to reveal the ports underneath
6. Attach the battery backup lead to the port shown. Note there may be a splitter cable already connected in which case connect battery backup to the lead labelled "TBB" of the splitter cable
7. Close the control box
8. Attach beds' power lead to power and wait 10 seconds
9. Secure battery backup lead to the frame in same locations as other cables are attached

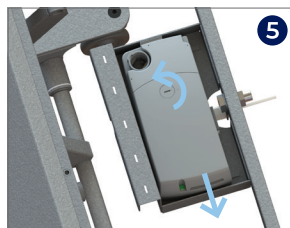
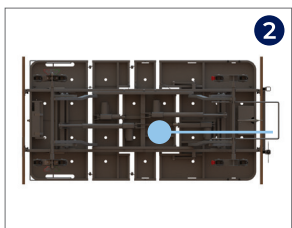

9.11 USB PORT UPGRADE KIT (SOLD SEPARATELY)

The USB Upgrade kit allows users to charge personal devices via conveniently located ports on the backrest. The ports can be mounted to either left or right side of the bed.

Carton Contents:

- 1 x USB Port
- 1 x Mounting Strip
- 1 x Splitter Cable
- Zip ties
- 2 x M4 long screws
- 2 x M4 short screws

Assembly of USB Port Upgrade Kit

1. Raise bed height and backrest to maximum height
2. Attach the USB port under the backrest (in between the mattress retainer handwheel bolts) using the long screws
3. Run the USB port cable under the back rest frame towards the beds' midsection, securing to the backrest using zip ties
4. From the middle of the bed, run the cable towards the other cables running under the bed. Join the USB ports' cable to the other cables and route towards the control box at the head end following the same path as the other cables
5. Use a flat head screw driver to turn the locking tab on the control box to unlocked position then slide the cover off to reveal the ports underneath
6. Attach the splitter cable to the port shown
7. Close the control box
8. Attach USB port cable to the splitter cable's port marked "TFA". If the bed has a battery backup it can be connected to the splitter cables' port marked "TBB"
9. Secure USB port cable to backrest, bed frame and other cables, ensuring enough slack is left to allow cable to adjust with bed movement



9.12 FULL LENGTH SIDE RAILS ASSEMBLY GUIDE

Full Length Rails – Set of 4

[BEB048785](#) Sublime Teak | [BEB048790](#) Milano Walnut

Bed End Set – Single

[BEB048750](#) Sublime Teak | [BEB048755](#) Milano Walnut

Bed End Set – King Single

[BEB048770](#) Sublime Teak | [BEB048775](#) Milano Walnut

Recommended Tools:

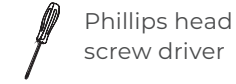

Phillips head screw driver



3mm Allen key

Full length side rails are designed to provide a safety barrier to minimise the risk of a resident falling from the bed. These are supplied as a full kit and cannot be used with standard head and foot boards.

Carton Contents:

As rails and bed ends are packaged separately, a full kit contains 2 x cartons.

Bed End Set (Carton 1)

- 1 Headboard
- 2 Footboard
- 3 2 x Head end board holders (short)
- 4 2 x Foot end board holders (long)

Full Length Rails Set (Carton 2)

- 5 4 x Wire guides
- 6 4 x End caps – Top
- 7 4 x End caps – Bottom
- 8 4 x Full length rails

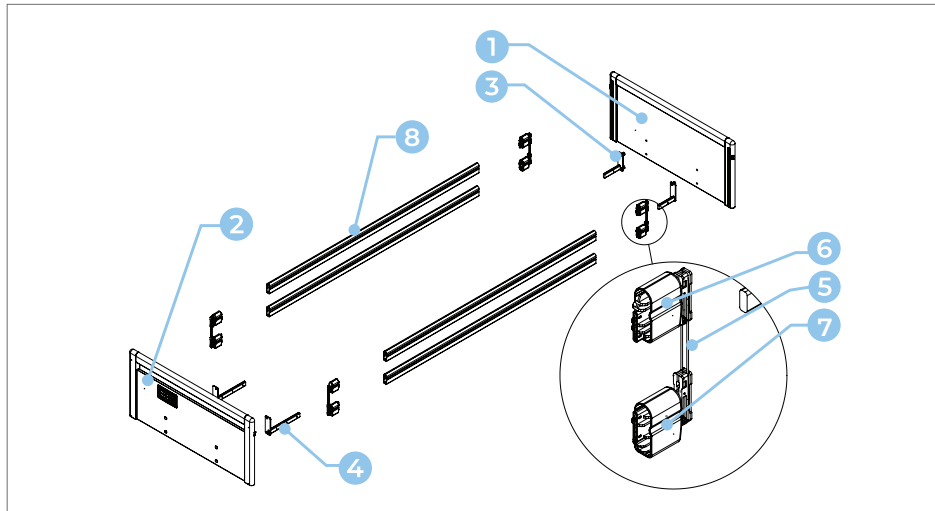

Assembly of the full length rails:

1. Remove existing head and foot boards and board holders from bed (if fitted) and put aside.

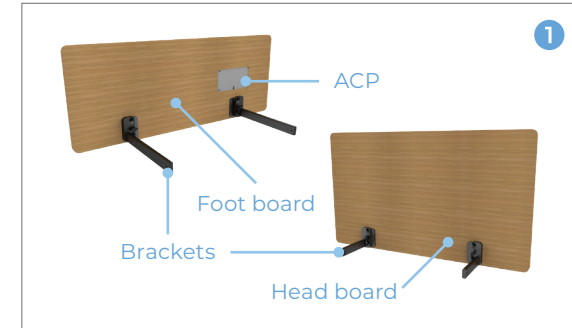

2. Assemble the board holders (3 & 4) to the new headboard (1) and footboard (2) for full length rails. Ensure the brackets are orientated towards each other as shown and are mounted to the same side of the board as the aluminium tracks.



Do not over tighten the bolts as this could damage the boards.

3. Insert new headboard (1) and footboard (2) onto the bed leaving a 10mm gap between the board and transport trolley receiver nut.



- Assemble the plastic end caps **6** & **7** and wire guide **5** as shown. Ensure that the top cap **6** slides up and down the wire easily. If assembly is correct top and bottom caps will not touch.
- Repeat step **4** until all four assemblies have been completed.

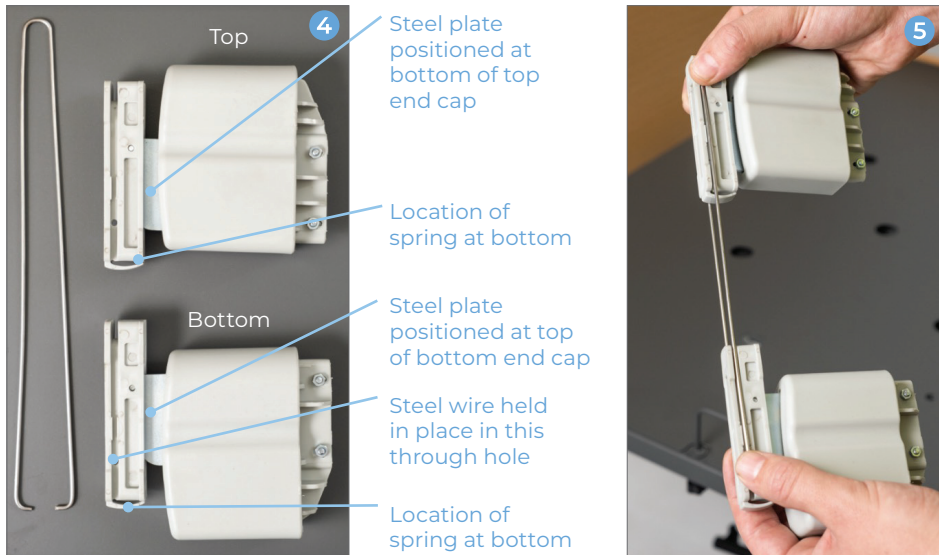

- Remove the bolt and spacer from the bottom of each of the four aluminium tracks.
- On the headboard **1**, slide plastic cap assemblies into the aluminium track and all the way to the top.
- Replace the bolt and spacer at the bottom of the track of the headboard **1** to prevent the end caps from falling out.

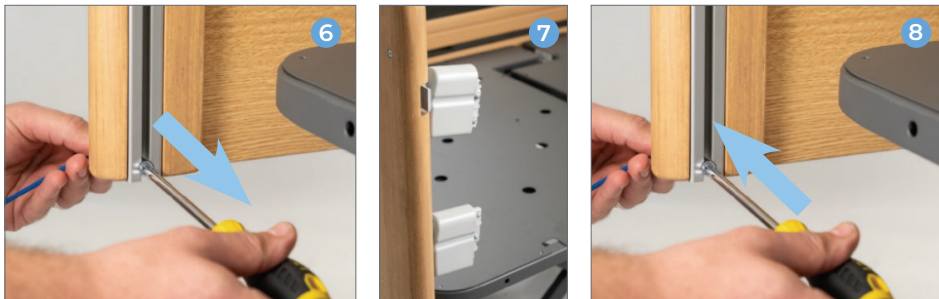

- On the headboard **1**, release the end cap assemblies by raising the top end cap **6** slightly and pressing the button. Let the end cap rest in the down position.
- Slide the footboard end caps **4** on to the rail ensuring correct orientation. Finally slot the rail **8** into end caps already on the headboard **1**.

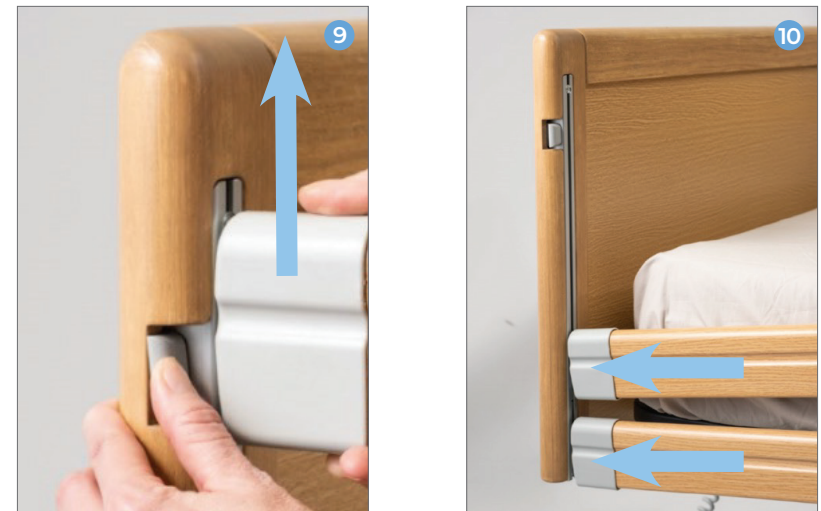

- Slide the foot end cap **7** assemblies into the foot board **2**. Slide rails all the way to the top and lock in place. Ensure wire **5** does not come loose during this step.
- Replace the bolt and spacer at the bottom of the track for the foot board **5**.

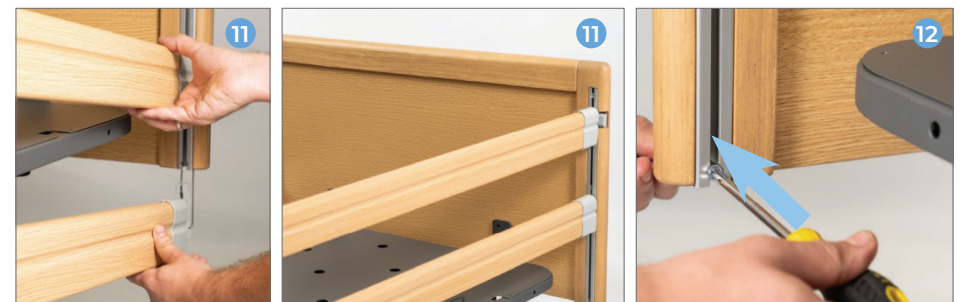

- Repeat steps **9** to **12** for other side of the bed.
- Assembly is now complete.

10. GENERAL OPERATION

10.1 CASTOR SYSTEM – BRAKES & STEERING

10.1.1 Central Locking Castors

Central locking castors are located at the foot end of the bed. The brakes are interlinked on either side of the bed allowing operation with a single movement for improved safety and efficiency.

1. To engage the brakes push down on the red pedal as shown below until bed is locked in place
2. To disengage brakes push down on the green pedal until the brake system is completely unlocked

Pedal Positions:



10.1.2 Total Locking Castors

Total locking castors are located at the head end of the bed

1. To engage the total lock, press the red pedal down
2. To disengage the total lock, pull up on the red pedal until unlocked

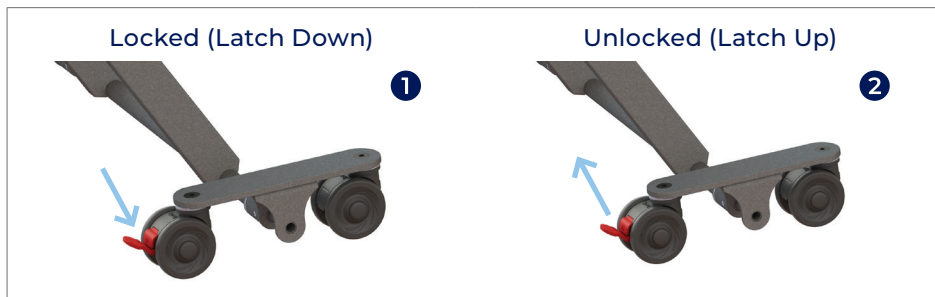

10.2 BED EXTENSION

The integrated bed extension can add 100mm / 4" or 200mm / 7.9" of length to the mattress platform.

Moving Bed Extension From Closed/Standard Bed Position

1. Move the foot end mattress retainer from the minimum position to the middle hole (100mm / 4" extension) or the furthest hole (200mm / 7.9")
2. If extending the mattress platform by 100mm / 4": loosen the handwheel bolts under the bed frame and pull out headboard by 100mm / 4". Tighten handwheels to lock in place
3. If extending the mattress platform by 200mm / 7.9": loosen the handwheel bolts under the bed frame and pull out headboard and its mounting brackets entirely. Replace the mounting brackets with the longer pair located under the leg section platform (remember to place the short pair and secure to frame under the leg frame for future use). Slide the headboard and brackets back into place and extend the platform by 200mm / 7.9". Tighten handwheels to lock in place



The bed extension is designed for use as a bed extension only and is not meant to support the body weight of a person sitting. The extra length of the bed with extra load can also make the bed unstable potentially resulting in injury to the user and patient.

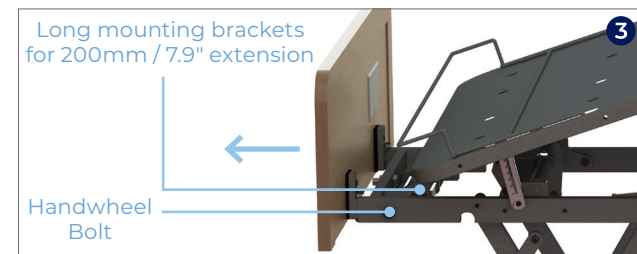
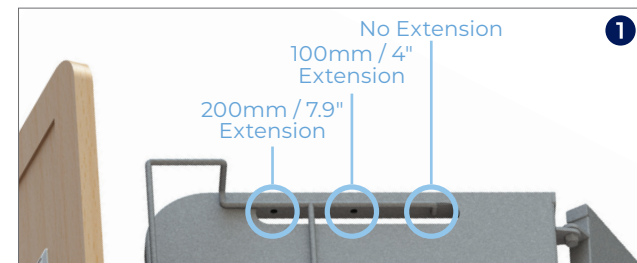

11. STORAGE & MOVEMENT



- **DISCONNECT** the bed power cord before moving the bed
- **DO NOT** remove the power cord from the source by pulling on the cord
- **DO NOT** pull on the power cord, or handset cord to manoeuvre the bed
- **ALWAYS** apply the brakes when the bed is in a stationary position

Handle With Care

FLX Beds should be stored in a clean, dry, well ventilated area.

Do not drop and avoid shock or violent impact when transporting.

The following limits apply during transport and or a storage period of up to 15 weeks duration:

Ambient temperature	-25°C – 70°C
Relative humidity	10% – 75%
Air pressure	50 kPa – 106 kPa

The following limits apply to normal operating conditions and or periods of storage longer than 15 weeks:

Ambient temperature	+10°C – 40°C
Relative humidity	30% – 75%
Air pressure	70 kPa – 106 kPa

Moving your FLX Bed

1. Before moving the bed, press the **ExitSafe** position button on the handset or ACP until it is in position
2. Release the brakes at head and foot end (see section 9.1)
3. Ensure handset is stored safely
4. Unplug the mains cable from the wall socket, coil up and place under the mattress (if no mattress in place hang over mattress retainer)

12. CLEANING



Before cleaning always disconnect the bed from the mains power source.

NOTE: It is strongly recommended that protective clothing be used when cleaning.

NOTE: The following procedure also applies to bed accessories, but does not include mattresses.

- Wipe the beds surfaces with a soft cloth moistened with hot water and mild detergent (or the facilities recommended cleaning solution). It is recommended that the cloth be a white material to prevent bleeding of die colours to the bed. Take extra care in areas that may harbour dirt or dust
- Rinse with clean water and dry with a clean cloth
- To remove potentially infectious materials such as body fluids, or when the bed has been used by someone with a known infection. Clean with NaDCC (e.g. Presept, Actichlor) at 10,000 ppm of available chlorine. Rinse and dry
- Allow the cleaned parts to dry before replacing the mattress



DO NOT use abrasive Hypocarbonate or Phenolic compounds or pads.

13. MAINTENANCE

To prolong the working life of the bed and for trouble free operation it is recommended that routine inspections should be performed by a person who is suitably qualified and well acquainted with the design, use and care of your FLX Bed.

If inspection reveals that the safety of the bed is jeopardised in any way, it should be **IMMEDIATELY WITHDRAWN FROM SERVICE**, tagged as such and the owner notified.

NOTE: Other than general maintenance activities all other service or repair work must be performed by qualified and trained persons who are approved by Aidacare.



The bed must be disconnected from the mains power supply before starting any maintenance activity.

General

- 1 Examine all the warning signs on the bed, examine the bed for obvious signs of damage. All aspects of the equipment should operate as intended. Check that all nuts, bolts and other fasteners are tight and are not missing
- 2 Examine flexible cables and conduits for cuts, cracks, abrasions or other deterioration
- 3 Check that the power supply plug is not damaged. If either the power cable or plug is damaged then both the cable and plug must be replaced as a complete assembly by an approved service agent
- 4 Check hi-lo rollers and track for signs of deterioration such as shavings, burrs, cuts, deformation or flat spots

Brake System

- 1 Activate brakes in the locked position and apply pressure to the bed foot end.
- 2 If the bed castors rotate the brakes should be adjusted accordingly
- 3 If the bed does not stay stationary the bed should be removed from service until the issues are rectified

Battery Backup

- 1 Check battery indicator light on attendant control panel to monitor condition of battery back-up

14. TROUBLESHOOTING

IMPORTANT!

Prior to making any adjustments to the electronics of the bed, the control box should always be reset to rule out any calibration issues.

Calibration issues can occur when power outages happen or when beds are unplugged from the wall during use.

To complete a reset:

1. Hold down the top two buttons of the handset (Top Left + Top Right)
2. After 5 seconds continue to hold and the bed will enter reset sequence
This will result in all actuators retracting to their minimum length which manifests as the bed flattening and descending to the lowest position
3. Once the bed reaches this position a faint relay “click” can be heard and the handset LED light will flash several times indicating reset procedure is complete
4. If the bed does not perform normally after being reset, please explore the trouble shooting guide suggestions

Effect	Possible Cause	Verification	Corrective Action
Bed does not stay in place	Braking system is not in Total Brake position Brake System is malfunctioning	Brake pedal is not engaged in lowest position Brake pedal is in lowest position, but bed does not stay in place	Brake pedal is not engaged in lowest position Contact your sales representative or a qualified Aidacare service technician
Bed does not move up or down	Bed is not plugged in and optional battery is flat Actuator is faulty Handset is faulty NCP is Faulty	Check if the power lead is plugged into mains power Swap actuators Swap handsets Swap NCP	If unplugged, plug power leads into mains power. Allow 3 hours to charge battery (if fitted) Conduct electronic system reset - refer to section 7.4 Contact your sales representative or a qualified Aidacare service technician
Backrest does not move up or down	Actuator code is unplugged Actuator is faulty Handset is faulty NCP is Faulty	Check if cables have come loose from control box (under top frame at head end) Swap handsets Swap Actuator Swap NCP	If loose, fully plug cables into control box Conduct electronic system reset - refer to section 7.4 Contact your sales representative or a qualified Aidacare service technician

15. WARRANTY & SERVICE

Aidacare FLX Beds carry a comprehensive warranty as detailed below. Please keep proof of purchase for proof of warranty commencement.

10 YEARS WARRANTY
Frame

3 YEARS WARRANTY
Electronics

1 YEAR WARRANTY
Handsets & Cable

Consumer Warranty Against Defects:

Aidacare is bound by Australian Consumer Law in respect to Warranty Against Defects. A copy of the Aidacare Warranty Against Defects statement is available on the Aidacare homepage at aidacare.com.au. All warranty matters should be directed to Aidacare Customer Service on **1300 133 120**.

Aidacare does not warrant against excessive or incorrect use, modification or any situation that could not be deemed as fair wear and tear. This is a back to base warranty and does not cover freight costs pertaining to the return of any items under warranty. Aidacare acknowledges and conforms to all ACCC guidelines around consumer rights. For further information contact Aidacare on **1300 133 120** or email product@aidacare.com.au.

Aidacare will not warrant the safety and or correct functioning of products where any original components have been changed or modified by non-Aidacare approved and trained service & maintenance staff or external providers. Furthermore, safety is not guaranteed where components have been replaced with non-original Aidacare approved parts. If any faults are detected upon receipt of this product please phone Aidacare. Any faults that are detected during normal use should be reported to Aidacare immediately to determine if warranty conditions apply and if so, the necessary repair or replacement work to be completed.

Spare parts list is available upon request.

For servicing, preventative maintenance and any other questions regarding this or any other Aidacare product please contact:

AUSTRALIA

Building 3A, 1 Moorebank Avenue,
Moorebank NSW 2170

1300 133 120 | aidacare.com.au

UK

Arcadia House, Maritime Walk,
Ocean Village, Southampton SO14 3TL

01622 541235 | aidacare.co.uk

16. RECYCLING INSTRUCTION

This product is fitted with electronic components and should not be mixed with general household waste. Please follow the diagram below to identify materials on the product. Old batteries and electronics are to be taken to your nearest recycling centre for recycling or contact your retailer.

Waste of Electrical and Electronic Equipment (WEEE)

Metals

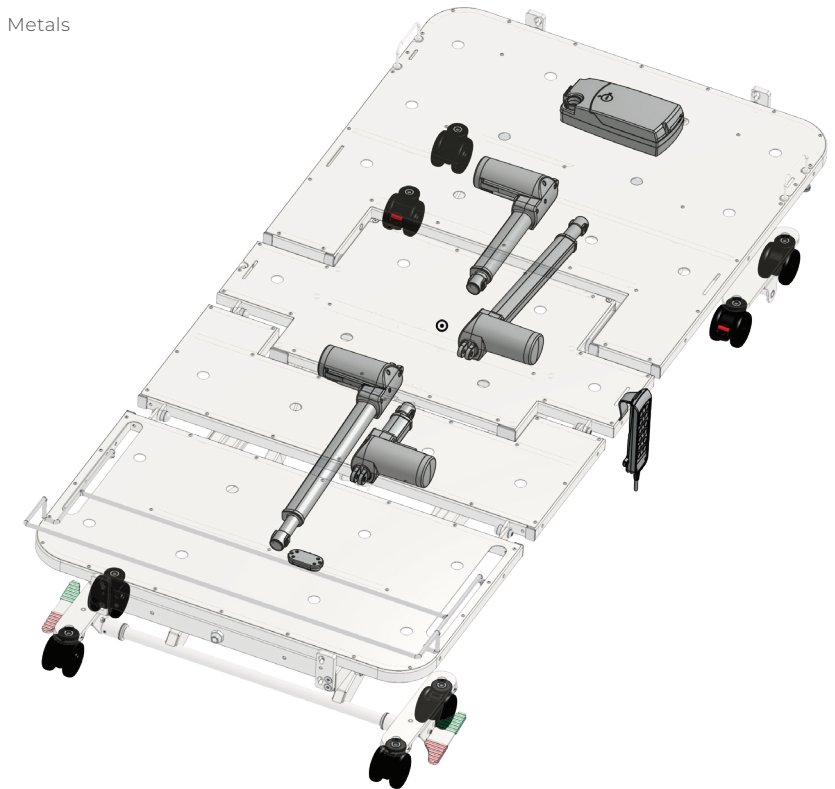

17. MANUFACTURER, EU REPRESENTATIVE & IMPORTER DETAILS

If you have any questions, you can contact:



Manufacturer:
Aidacare Pty Ltd

ABN 40 134 398 833

Building 3A, 1 Moorebank Avenue,
Moorebank NSW 2170
Australia

1300 133 120 | product@aidacare.com.au



EU Representative:
European Healthcare & Device Solutions (Ireland) Ltd

Stratton House, Bishopstown Road
Cork T12 Y9TC
Ireland

info@europeandevicesolutions.eu



Importer:
Aidacare Ltd

Registration 13785408

Arcadia House, Maritime Walk, Ocean Village,
Southampton SO14 3TL
United Kingdom

01622 541235 | info@aidacare.co.uk

18. SERVICE LOG BOOK

Year 1

Date: _____

Service Type: _____

Condition Report: _____

Inspected by: _____ Signature: _____

Action taken: _____ Date: _____

Year 2

Date: _____

Service Type: _____

Condition Report: _____

Inspected by: _____ Signature: _____

Action taken: _____ Date: _____

Year 3

Date: _____

Service Type: _____

Condition Report: _____

Inspected by: _____ Signature: _____

Action taken: _____ Date: _____

Year 4

Date: _____

Service Type: _____

Condition Report: _____

Inspected by: _____ Signature: _____

Action taken: _____ Date: _____

Year 5

Date: _____

Service Type: _____

Condition Report: _____

Inspected by: _____ Signature: _____

Action taken: _____ Date: _____

AIDACARE PTY LTD

Building 3A, 1 Moorebank Avenue,
Moorebank NSW 2170
Australia

1300 133 120 | aidacare.com.au

AIDACARE LIMITED

Arcadia House, Maritime Walk,
Ocean Village, Southampton SO14 3TL
United Kingdom

01622 541235 | aidacare.co.uk

MADE IN PRC

ASUM19.16 060824

