



POSTUREPRO & POSTUREPRO PLUS PRESSURE REDUCING CHAIRS

USER MANUAL



PosturePro
Pressure Reducing Chair



PosturePro Plus
Pressure Reducing Chair

Thank you for choosing the Aspire PosturePro or PosturePro Plus Chair.

This chair is carefully designed to provide optimal comfort,
support, and safety.

**Please read this user manual thoroughly to ensure proper
and safe use of your new Pressure Reducing Chair.**

© Aidacare Pty Ltd 2025

No part of this user manual may be copied, distributed, reproduced, scanned or stored on any electronic database, whether in whole or in part in any form or by any means.

Due care has been taken to ensure all the information contained in this user manual is correct at the time of printing. All measurements, pictures, colours and weight capacities are to be used as a guide only. We reserve the right to modify the design or appearance of any product displayed in this user manual without prior notice.

TABLE OF CONTENTS

1. Symbols Used in Manual	4
2. Symbols on this Product	5
3. Introduction	6
4. Warnings	7
5. Overview of Your PosturePro Chair	8
6. Operation Instructions	11
7. Accessories & Custom Options	17
8. Care And Maintenance	18
9. Warranty Information	19
10. Compliance Standards	19
11. Service Maintenance & Customisation	19
12. Recycling Instructions	20
13. Product Specifications	20
14. Manufacturer Information	21

1. SYMBOLS USED IN MANUAL

The symbols listed below are used throughout this manual and on the product to highlight warnings and important information. It is essential to familiarize yourself with these symbols to ensure safe and proper use of the chair.



WARNING

WARNING! Indicates a potentially hazardous condition/situation. Failure to follow designated procedures can cause either personal injury, component damage or malfunction. On the product, this icon is represented as a black symbol on a yellow triangle with a black border.



MANDATORY! These actions should be performed as specified. Failure to perform mandatory actions can cause personal injury and/or equipment damage. On the product, this icon is represented as a white symbol on a blue dot with a white border.



PROHIBITED! These actions are prohibited. These actions should not be performed at any time or in any circumstances. Performing a prohibited action can cause personal injury and/or equipment damage. On the product, this icon is represented as a black symbol with a red circle and red slash.

Please fill out the following information for quick reference:

Aspire Dealer	
Address	
Phone Number	
Purchase Date	
Serial Number	

NOTE: This owner's manual is compiled from the latest specifications and product information available at the time of publication. We reserve the right to make changes as they become necessary. Any changes to our products may cause slight variations between the illustrations and explanations in this manual and the product you have purchased. The latest/current version of this manual is available on our website.

2. SYMBOLS ON THIS PRODUCT

PRODUCT SAFETY SYMBOLS

The symbols below are used on the product to indicate warnings, mandatory actions, and prohibited actions. It is crucial to understand each symbol to ensure safe operation and prevent accidents. Do not remove these labels from your product. Please note that not all of the symbols may be used on your PosturePro and PosturePro Plus Pressure Reducing Chair model.



	Product Code		Safe Working Load
	Serial Number		Read User Manual
	Manufacturer		Caution
	Country of Manufacture		

3. INTRODUCTION

INTENDED USE

The Aspire PosturePro and PosturePro Plus Pressure Reducing Chairs are designed for individuals with limited mobility or postural challenges. These chairs provide essential support for users who have difficulty standing or require additional seating assistance due to various medical conditions.

SAFETY

CONGRATULATIONS on purchasing your Aspire PosturePro Pressure Reducing Chair. The product you have purchased combines state-of-the-art components with **safety**, comfort and styling in mind. We are confident the design features will provide you with the conveniences you expect during your daily activities. Understanding how to **safely** operate and care for this product should bring you years of trouble-free operation and service.

Read and follow all instructions, warnings and notes in this manual and all other accompanying literature before attempting to operate this product for the first time. In addition, your **safety** depends upon you, as well as your dealer, carer or healthcare professional in using good judgement.

If there is any information in this manual which you do not understand, or if you require additional assistance for setup or operation, please contact your authorised Aspire Dealer.

Failure to follow the instructions, warnings and notes in this manual and those located on your Aspire product can result in personal injury or product damage and will void the Aspire product warranty.

PURCHASER'S AGREEMENT

By accepting delivery of this product, you promise that you will not change, alter or modify this product or remove or render inoperable or unsafe any guards, shields or other safety features of this product; fail, refuse or neglect to install any retrofit kits from time to time provided by Aspire to enhance or preserve the safe use of this product.

INFORMATION EXCHANGE

We want to hear your questions, comments and suggestions about this manual. We would also like to hear about the safety and reliability of your new PosturePro Pressure Reducing Chair and about the service you received from your authorised Aspire Dealer. Please notify us of any change of address, so we can keep you apprised of important information about safety, new products and new options that can increase your ability to use and enjoy your PosturePro Pressure Reducing Chair.

Please feel free to contact Aidacare.

NOTE: If you ever lose or misplace your product registration card or your copy of this manual, contact us and we will be glad to send you a new one immediately.

4. WARNINGS

WEIGHT LIMITATIONS

The Aspire PosturePro Pressure Reducing Chair has a maximum user weight capacity of 140 kg.



MANDATORY! Stay within the specified weight capacity of your PosturePro Pressure Reducing Chair. Failure to do so may result in injuries and/or product damage, Aidacare will not be held responsible for any such issues/failures.

PINCH & CRUSH HAZARDS

There are potential pinch hazards when handling the chair or its accessories. Be cautious around moving parts of your Aspire PosturePro Chair.



WARNING! Do not place objects or appendages in the path of moving parts.



Do not place objects under the PosturePro Pressure Reducing Chair. Make sure the area is clear of obstructions, including pets and small children during operation



Indoor use only. Avoid exposure to rain, snow, ice, salt or standing water. Maintain and store in a clean and dry environment



Do not place objects under the footrest when the PosturePro Pressure Reducing Chair is in the fully reclined position. Make sure area is clear of obstructions, including pets and small children during operation

5. OVERVIEW OF YOUR POSTUREPRO CHAIR

BODY COMPONENTS

This section outlines the key features of your Aspire PosturePro Pressure Reducing Chair. Review each function and its location carefully. Please note that illustrations and options shown in this manual may vary depending on the specific model of PosturePro Chair you own.

FIGURE 5.1 POSTUREPRO PRESSURE REDUCING CHAIR MAIN COMPONENTS

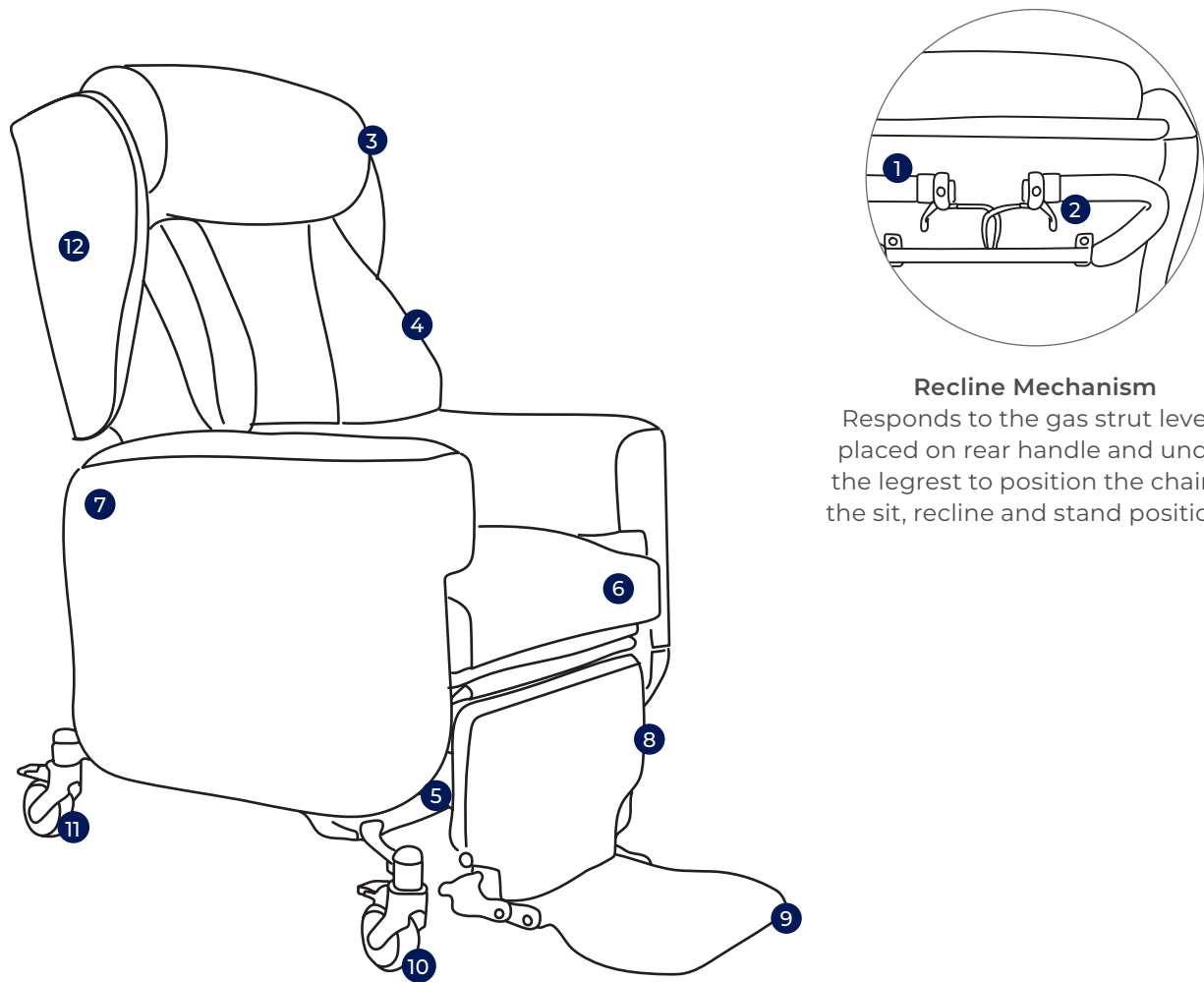

Recline Mechanism

Responds to the gas strut levers placed on rear handle and under the legrest to position the chair in the sit, recline and stand positions.

1	Back Recline Lever	2	Tilt Lever	3	Head Rest Cushion
4	Adjustable Back & Lateral Support Cushion	5	Legrest Release Lever	6	Seat Cushion
7	Removable Arm Rest Cushion	8	Retractable Calf Pad	9	Adjustable Padded Foot Rest
10	Directional Locking Castor	11	Total Locking Castor	12	Removable Wings

BODY COMPONENTS

This section outlines the key features of your Aspire PosturePro Plus Pressure Reducing Chair. Review each function and its location carefully. Please note that illustrations and options shown in this manual may vary depending on the specific model of PosturePro Plus Chair you own.

FIGURE 5.2 POSTUREPRO PLUS PRESSURE REDUCING CHAIR MAIN COMPONENTS

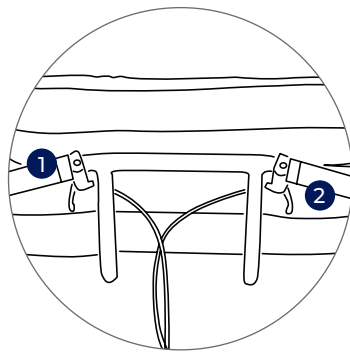

Recline Mechanism

Responds to the gas strut levers placed on rear handle and under the legrest to position the chair in the sit, recline and stand positions.

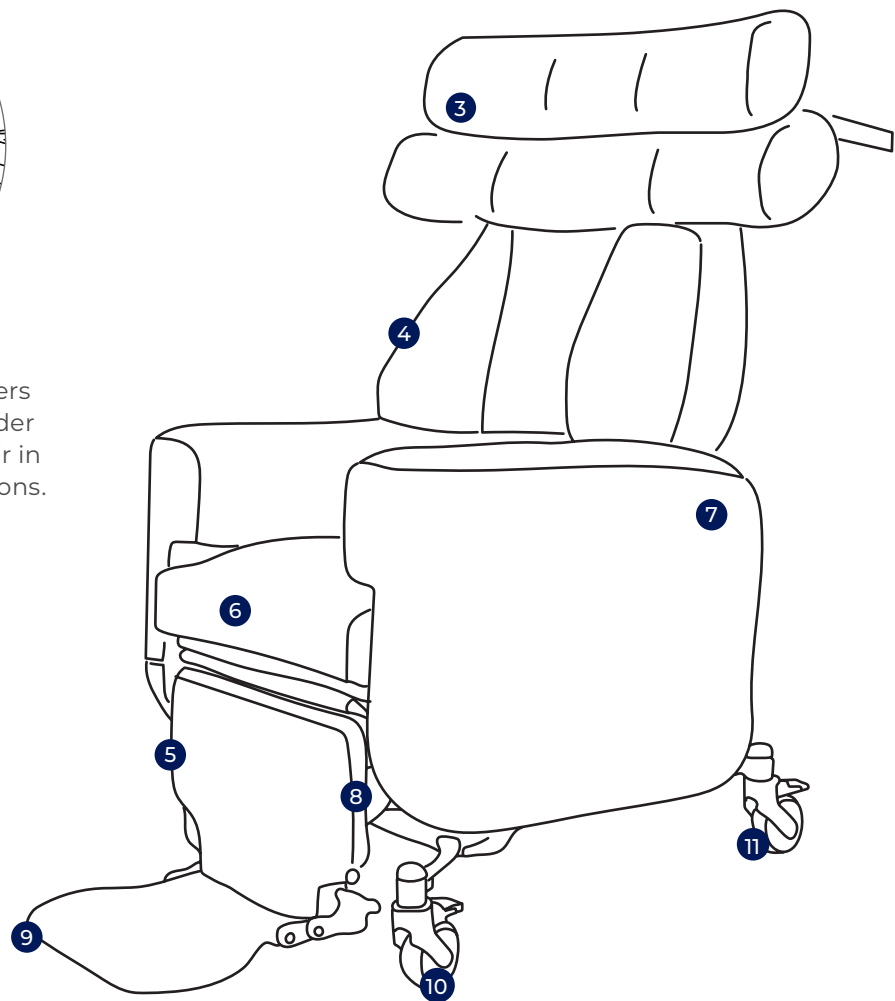

1	Back Recline Lever	2	Tilt Lever	3	Head Rest Cushion
4	Adjustable Back & Lateral Support Cushion	5	Legrest Release Lever	6	Seat Cushion
7	Removable Arm Rest Cushion	8	Retractable Calf Pad	9	Adjustable Padded Foot Rest
10	Directional Locking Castor	11	Total Locking Castor		

FIGURE 5.3 SCISSOR MECHANISM

The scissor mechanism extends or retracts to move the chair through various reclining positions.



WARNING! Pinch/Crush Points Hazard! Be aware that the legrest mechanism contains pinch points. Keep the follow items and similar objects clear of the legrest when operating the PosturePro:

- Appendages
- Small children
- Pets
- Wires
- Oxygen tubes
- Loose items, including but not limited to clothing and blankets
- Electrical power leads

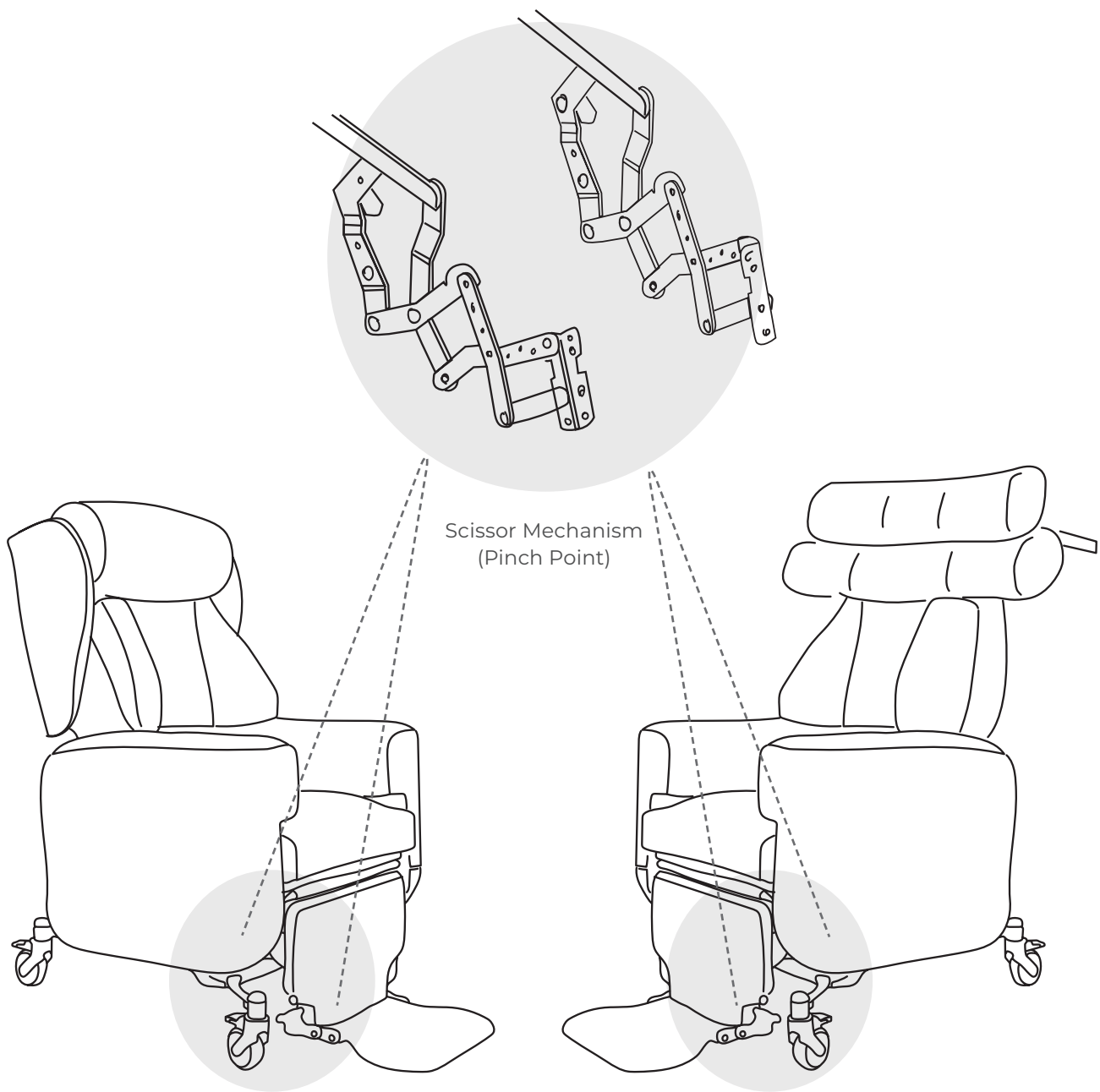

PosturePro Pressure Reducing Chair

PosturePro Plus Pressure Reducing Chair

6. OPERATION INSTRUCTIONS

SAFE OPERATING PRECAUTIONS

It is important to take specific precautions while operating your Aspire PosturePro Pressure Reducing Chair. Follow these instructions carefully to ensure safe use and to prevent injury or damage.

- Keep children and pets away from all moving parts while operating the PosturePro Pressure Reducing Chair.
- Do not allow children to play on or operate the PosturePro Pressure Reducing Chair. Only the intended carer/assistant should operate the PosturePro Pressure Reducing Chair.
- Avoid pinch points, such as the legrest mechanism. Keep hands and feet clear of these areas
- Always leave the PosturePro Pressure Reducing Chair in an upright and closed position when not in use.
- Do not sit on the footrest.
- Do not stand on the footrest unless it is fully resting on a flat ground.



PROHIBITED! Do not place objects under the PosturePro Pressure Reducing Chair. Make sure area is clear of obstructions, including pets and small children during operation.



WARNING

WARNING! Prevent the risk of fire, falls and/or being pinched. Follow all instructions and precautions provided.

6.1 ADJUSTING THE SEAT TILT

The seat can be tilted to enhance user comfort and provide relief. A locking gas strut controls the tilt position. To adjust, press the thumb toggle on the handlebars and release it when the desired position is reached. Ensure the armrests are locked before making adjustments.

PosturePro Pressure Reducing Chair



Tilt Adjustment
Thumb Toggle



PosturePro Plus Pressure Reducing Chair



Tilt Adjustment
Thumb Toggle



6.2 ADJUSTING THE BACK RECLINE

The backrest can be reclined for enhanced comfort. A locking gas strut controls the recline. To adjust, press the thumb toggle on the handlebars, and release it when the desired recline angle is reached. Always ensure the armrests are locked before adjusting the backrest.

PosturePro Pressure Reducing Chair



Recline Adjustment
Thumb Toggle



PosturePro Plus Pressure Reducing Chair



Recline Adjustment
Thumb Toggle



6.3 SEAT HEIGHT ADJUSTMENT

The seat height can be adjusted into 3 x increments by adjusting the side mounts/armrests and the tilt gas strut, allowing up to 50mm of movement.



WARNING

WARNING! Adjustment is to only be performed by an Aidacare Technician or Equipment specialist.

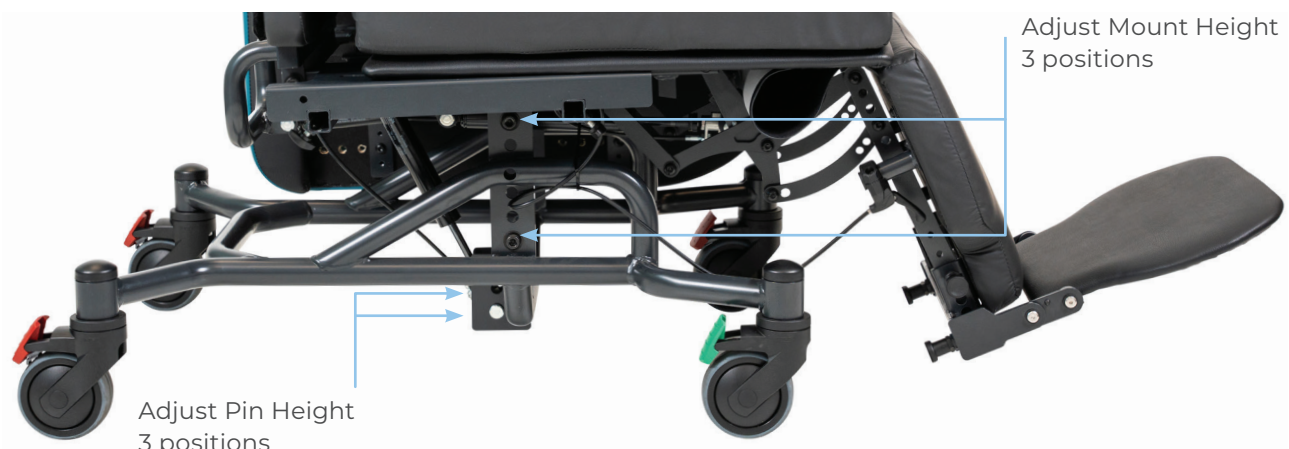

6.4 SEAT DEPTH ADJUSTMENT

The seat frame can be adjusted forward and back by releasing and tightening the front and rear hand screws on both sides underneath the seat base.



WARNING

WARNING! Ensure the hand screws are tightened to prevent any seat base movement.



6.5 SEAT WIDTH ADJUSTMENT

The Seat width of Posturepro and PosturePro Plus can be adjusted to suit the individual user needs.

To adjust the seat width, simply release 2x hand bolts securing the armrest to the seat frame, move the armrest and tighten them once the desired seat width is achieved.



6.6 HEIGHT AND DEPTH ADJUSTABLE ARMREST

Posturepro allows you to move your armrest forward/backward or raise/lower to optimise the user comfort.

To adjust the armrest height/ depth, remove the armrest from the chair and place it on a table with internal brackets pointing up.

Height and Depth can be adjusted to a number of predetermined positions by removing the 4 x hand bolts and fixing them once the brackets are repositioned.

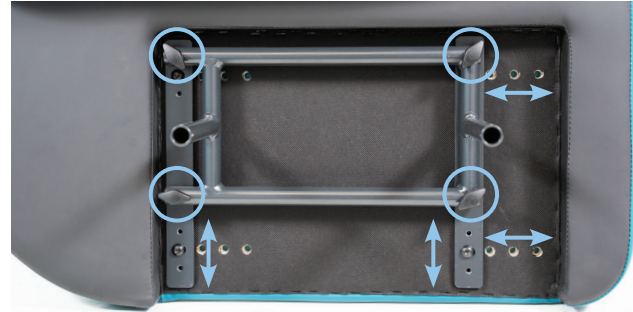

Internal part of the Armrest shown

6.7 DEPTH ADJUSTABLE LEGREST

Legrest depth can be adjusted to suit the increased seat depth for taller users. Increasing/decreasing the legrest depth can be done by simply loosening the hand bolt without the need of any tools.

6.8 ANGLE AND HEIGHT ADJUSTABLE FOOTREST

The footrests can be raised and lowered as well as angle adjusted to provide relief and comfort to the occupant. They can be positioned with a retention pin. To adjust the footrests open the retention pins and adjust the angle and height for comfort. Re-affix the retention pin.



Footrest angle adjustment indexing plunger pin
Footrest height adjustment indexing plunger pin
Legrest Adjustment Release Lever

6.9 MOVING THE CHAIR

The chair can be moved with the occupant seated. The chair can be used indoors and in a limited capacity outdoors. Ensure when moving the chair, the travel surface is smooth. Use the handle bars at the rear to guide and control the movement of the chair. Use the directional castor as needed. Always make sure the arms are locked prior to and when moving the chair with an occupant seated.



WARNING

WARNING: DO NOT move the chair when in full tilt and recline position with an occupant in the chair.

6.10 TRANSFERRING AN OCCUPANT

Prior to transferring an occupant into or out of the chair, ensure all castors are locked. The method of transfer of an occupant depends on the instructions of your medical professional. Occupants can seat themselves and / or be hoisted into the chair. To facilitate the transfer of an occupant, the arms can be removed in the seated positions.



WARNING

WARNING: NEVER leave an occupant unattended when in full tilt and recline position or when the arms are removed.

WARNING: ALWAYS return the arms and lock into their original removed position once transfer is complete and before moving the occupant

6.11 ANTERIOR TILT ADJUSTMENT

PosturePro chairs can be configured to provide an Anterior Tilt to help Sit-To-Stand transfers. The figures below will show the Gas strut positions to add or remove anterior tilt at 3 different seat heights.

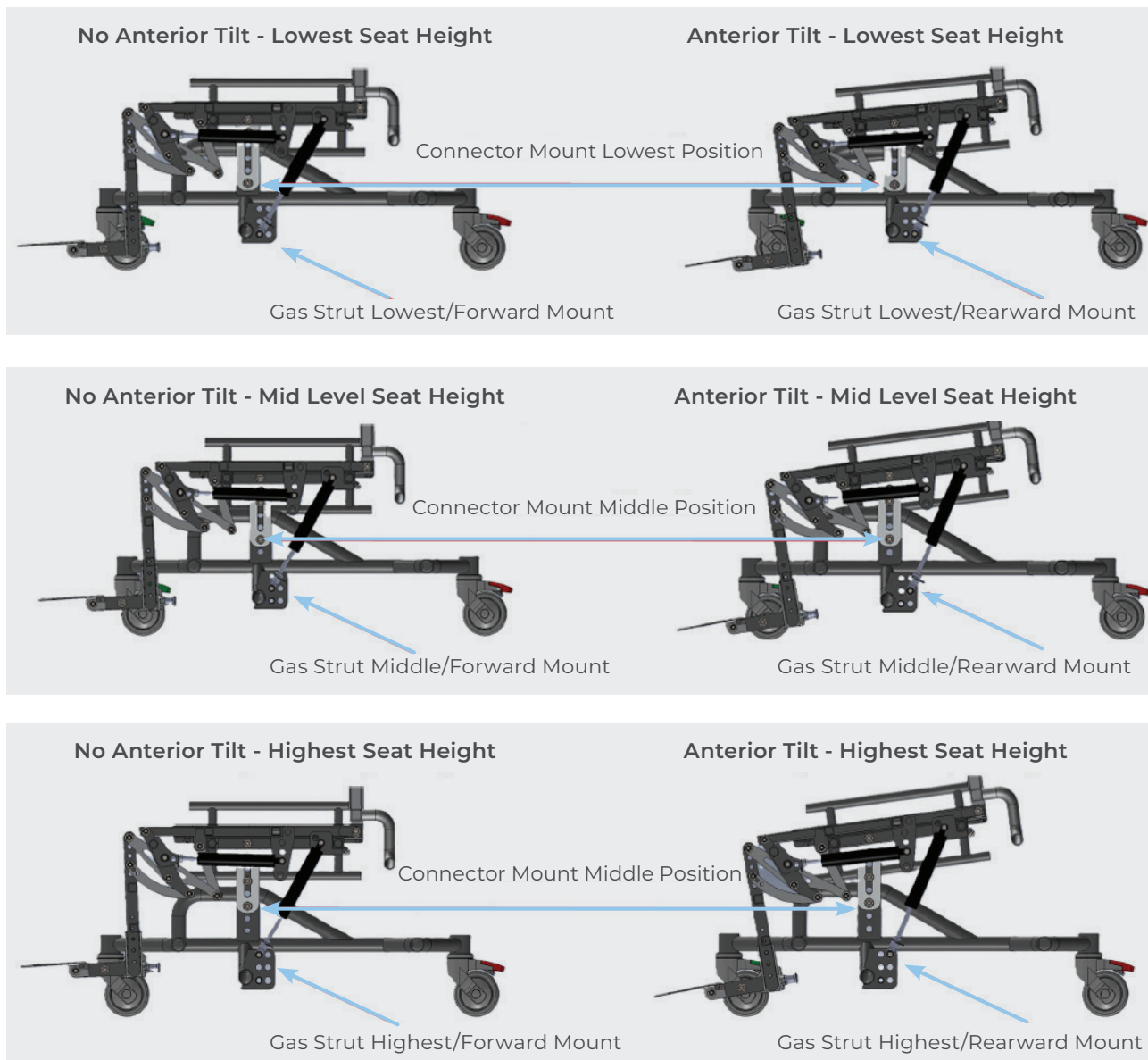

6.12 CORRECT AND INCORRECT USE GUIDE

DOS AND DO NOTS

DOS

SITTING

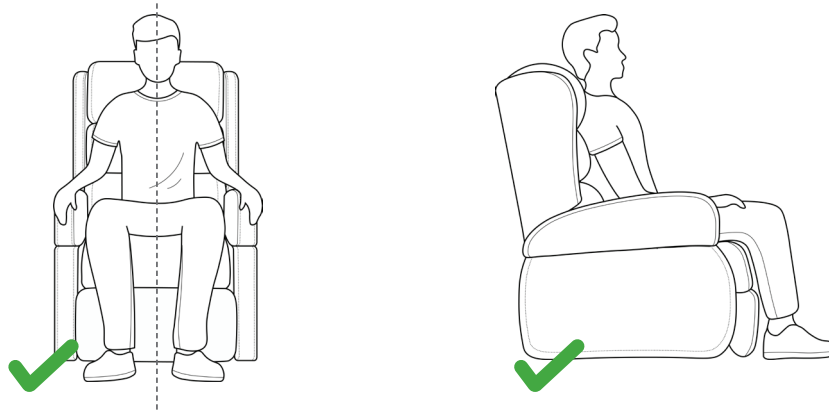

DO sit upright and centrally aligned in the chair.

LAYING

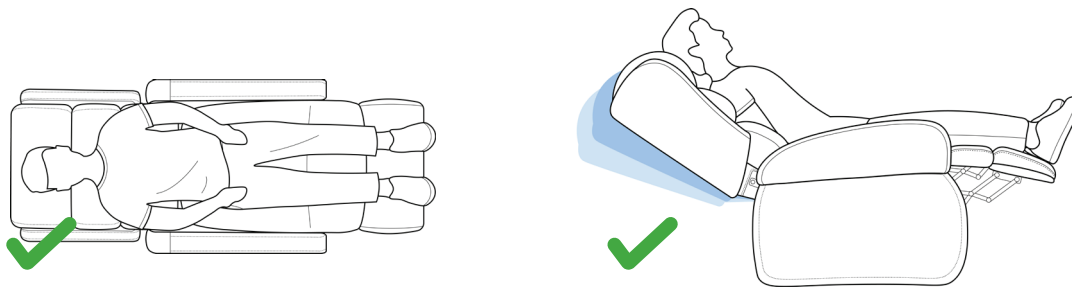

DO lie centrally and flat on the users back.

DO NOTS



Misuse may injure the user, cause pressure and/or skin tear related issues, as well as damage the product.

SITTING

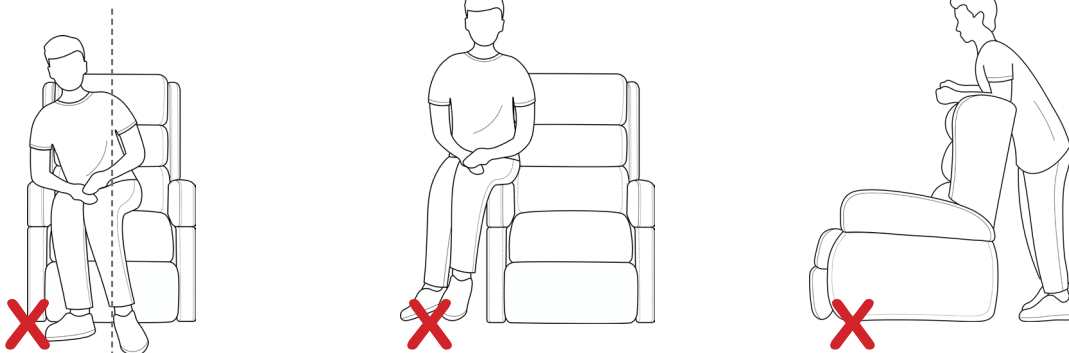

DO NOT sit skewed to one side of the chair.

DO NOT sit on the armrest.

DO NOT distribute excess weight on the backrest.

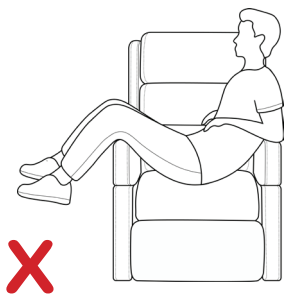

DO NOT distribute excess weight on the armrest.

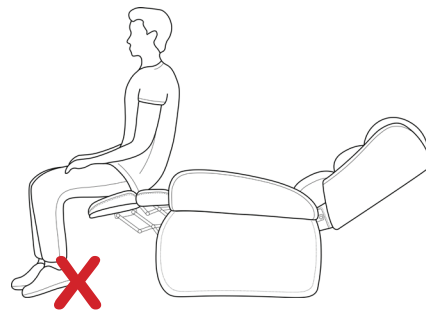

DO NOT sit on the footrest when extended.

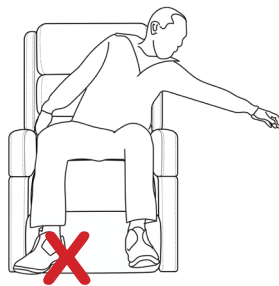

DO NOT reach to the side.

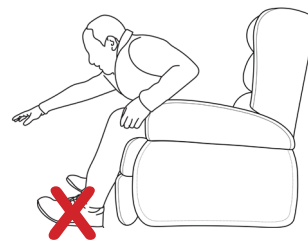

DO NOT lean forward.

LAYING

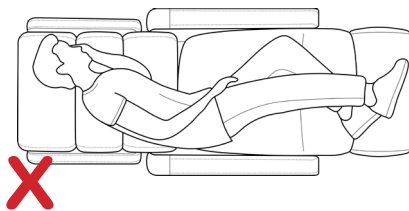

DO NOT lie on the side.

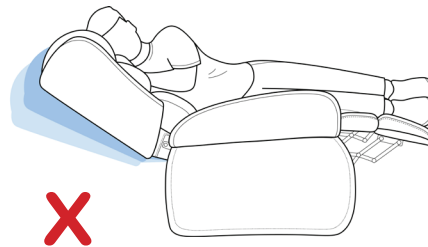

DO NOT reposition whilst on side.



Chairs shown are for illustrative purposes only and may not be reflective of the specific chair model purchased.

7. ACCESSORIES & CUSTOM OPTIONS

ACCESSORIES

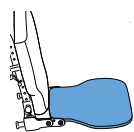

Footrest Padding
CHP231650

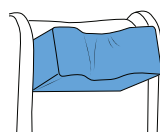

Concave Pillow
CHP231660

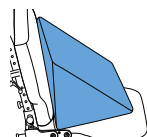

Legrest Wedge
CHP231670

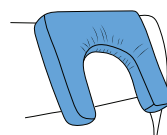

Horse Shoe Pillow
CHP231680

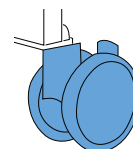

Twin Total Locking Castor
GSP511900

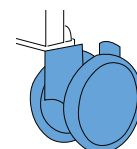

Twin Directional Locking Castor
GSP511905

8. CARE AND MAINTENANCE

Routine maintenance checks are necessary to keep your Aspire PosturePro Pressure Reducing Chair functioning optimally. While some checks can be performed by the user, others may require assistance from an authorised Aspire Dealer. Adhering to the maintenance schedule in this section will ensure years of reliable performance.

MAINTENANCE SCHEDULE

Weekly	<ul style="list-style-type: none"> • Check brakes are functioning properly • Check all fastenings such as nuts, bolts and hinges are fastened correctly and functioning normally
Periodically	<ul style="list-style-type: none"> • Check for signs of wear on front castors
Yearly	<ul style="list-style-type: none"> • Service to be completed by authorised Aspire service agent
Serviceable Components	<ul style="list-style-type: none"> • Castors • Gas struts and cables • Backrest, seat, armrest, legrest and wings upholstery • Footrest, rear handles

FABRIC AND UPHOLSTERY CARE

Inspect the fabric on a regular basis for any pulls, tears or gaps.

PosturePro chair outer surface is upholstered with vinyl on the outside and pressure reducing material on the user surface. Cleaning with damp cold soapy cloth and a clear cold water rinse is recommended.

Pressure reducing material must NOT be cleaned with abrasive cleaning agents, hydrogen peroxide, iodophors, phenolics, or ammonium compounds.

ASPIRE POSTUREPRO & POSTUREPRO PLUS PRESSURE REDUCING CHAIR

- **Pressure care (PosturePro & ProaturePro Plus Pressure Reducing Chair):**
Multi-stretch pressure reducing patient surface - Pressure reducing material
(Refer to the Warranty section for more information).



WARNING

WARNING! Fabric should not be allowed to come in direct contact with any type of heat source (e.g a space heater or cigarette). Personal injury or fire damage may occur.

WARNING! It is strongly recommended that you do not smoke cigarettes while seated in or using your PosturePro Pressure Reducing Chair, although the PosturePro Pressure Reducing Chair has passed the necessary testing requirements for cigarette smoking. You must adhere to the following safety guidelines if you decide to smoke cigarettes while seated in or using your PosturePro Pressure Reducing Chair.

- Do not leave lit cigarettes unattended.
- Keep ashtrays a safe distance from the PosturePro Pressure Reducing Chair.
- Always make sure cigarettes are completely extinguished before disposal.

PLEASE NOTE:

- Do not use solvent-type cleaners to spot clean.
- Do not saturate the fabric.
- Prevent damage to the fabric; do not expose the PosturePro Pressure Reducing Chair to direct sunlight.

9. WARRANTY INFORMATION

2 YEARS WARRANTY
Frame

1 YEAR WARRANTY
Components

Aspire PosturePro come with a 2-year warranty (frame) and a 1 year warranty (components).

Please keep purchase invoice as proof of warranty commencement.

This product comes with a warranty that varies by component. The frame is covered by a 2-year warranty, while all other components, except consumables (castors, foams, and upholstery), are covered by a 1-year warranty. Consumable parts are covered against manufacturer defects for 1 year but do not include wear and tear from normal use.

For further information contact Aidacare.

1 YEAR WARRANTY
Fabric

'Fabric and Upholstery Care' instructions specific to your Aspire PosturePro are located in the 'Care and Maintenance' section of this user manual. Failure to follow, protect and/or care for the upholstery/textile in the intended way (refer to 'Care and Maintenance' section) will void product warranty.

10. COMPLIANCE STANDARDS

The Aspire PosturePro Chairs are manufactured in ISO-compliant facilities in P.R. China, adhering to strict quality control standards. Aspire PosturePro Chairs are also independently tested to meet all relevant market compliance standards.

Labels on the chair address compliance requirements and users should familiarise themselves with these prior to use.

11. SERVICE MAINTENANCE & CUSTOMISATION

For all enquiries, please contact your local Aidacare branch.

SPARE PARTS

Aidacare stocks replacement parts for the Aspire PosturePro range. All part replacements should be carried out by Aidacare or an authorized Aspire service technician. Spare parts include, but are not limited to, castors, gas struts, levers, the frame, and upholstery.

A full list of replacement parts is available upon request.

CUSTOMISATION AND MODIFICATION

Any customisations, modifications, or alterations to this product are considered 'custom' changes. These may prevent the product from meeting safety standards and should be carefully considered before proceeding. Customisation or modification of the Aspire PosturePro Chair is not warranted by Aidacare and will void the warranty.

12. RECYCLING INSTRUCTIONS

The Aspire PosturePro Chairs are made from metal and plastic components, which can be recycled through standard recycling processes in your city.

13. PRODUCT SPECIFICATIONS

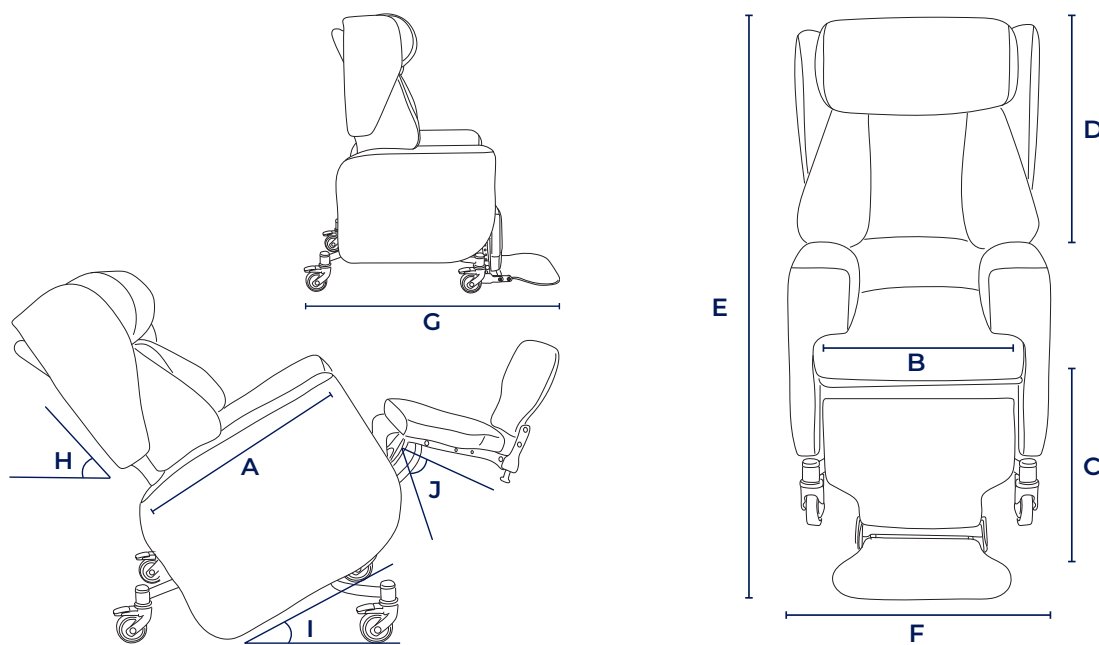

Dimensions	CHP231600 PosturePro	CHP231610 PosturePro PLUS
A Seat Depth Range	450 - 540mm	450 - 540mm
B Seat Width	330 - 530mm	330 - 530mm
C Seat to Foot Plate	530 - 590mm	530 - 590mm
D Backrest Height	770mm	777 - 900mm
E Overall Height	1300 - 1360mm	1111 - 1400mm
F Overall Width	650 - 850mm	650 - 888mm
G Overall Depth	950mm	950mm
Tilt & Recline Range		
H Backrest Tilt Angle Range	90 - 130°	90 - 130°
I Seat Tilt Angle Range	-5 - +32°	-5 - +32°
J Leg Elevation Range	0 - 35°	-5 - 30°

14. MANUFACTURER INFORMATION

If you have any questions, you can contact:



Manufacturer:

Aidacare Pty Ltd

ABN 40 134 398 833

Building 3A, 1 Moorebank Avenue,
Moorebank NSW 2170
Australia

1300 133 120 | product@aidacare.com.au

AIDACARE PTY LTD

Building 3A, 1 Moorebank Avenue,
Moorebank NSW 2170
Australia

1300 133 120 | aidacare.com.au

MADE IN PEOPLE'S REPUBLIC OF CHINA (PRC)

ASUM124.7 130325

