

aspire POSTUREPRO CHAIR RANGE

The PosturePro range offers highly adjustable seating solutions designed to deliver optimal pressure care and postural support for individuals who sit for extended periods.



POSTUREPRO

Optimised Seating for Comfort and Support

The PosturePro provides medium to high postural support and enhanced comfort for extended sitting periods. Its design incorporates memory foam, air bladders, and multi-stretch fabric to deliver effective pressure relief while maintaining user comfort.

- 1 Seat Tilt Angle Range -5 - +32°*
- 2 Backrest Tilt Angle Range 90 - 130°
- 3 Adjustable Seat Depth 450 - 540mm
- 4 Adjustable Seat Width 330 - 530mm
- 5 Arm Height & Depth Adjustability
- 6 Adjustable Pocketed Backrest Design
- 7 Leg Elevation Range 0 - 35°
- 8 Pressure Care Cushion



*Anterior tilt of -5 degree can be achieved with repositioning the tilt gas strut



COMMON FEATURES ACROSS MODELS



Customisable Backrest with Integrated Laterals

Provides side support to promote an upright posture and minimise lateral leaning, helping users maintain proper alignment during prolonged sitting.

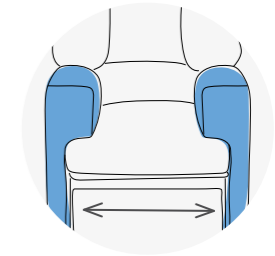

Tool Free Seat Depth & Width Adjustment

Allows quick and easy adjustments without tools. Therapists or carers can customise the seating dimensions for a better fit and comfort.

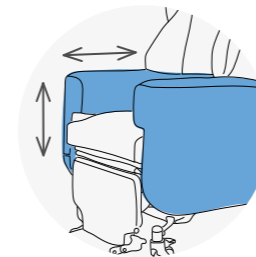

Height and Depth Adjustable Armrests

Enables precise armrest adjustments for correct arm positioning. Improves comfort and provides extra support during extended sitting.

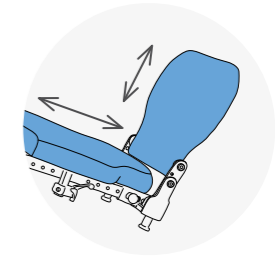

Angle & Depth Adjustable Footrest

Adjusts the footrest to suit the user's positioning and weight-bearing needs. Supports sit-to-stand transfers and promotes better posture.



Standing Aid Compatibility

Works with the Aspire Star Mover and most Aspire patient lifters. Enables safe and efficient standing transfers.

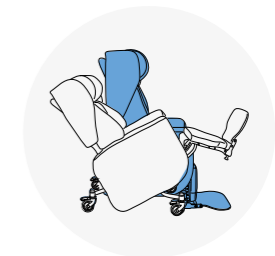

Infinite Positioning Options

Offers a range of tilt and recline positions for easy user repositioning. Improves comfort, relieves pressure, and helps prevent pressure injuries.

POSTUREPRO PLUS

A Practical Solution for Complex Postural & Comfort Needs

The PosturePro Plus is designed for individuals with complex or evolving needs, providing high levels of postural support and effective pressure care. It combines memory foam, air bladders, and multi-stretch fabric to deliver targeted pressure relief while maintaining user comfort.

- 1 Seat Tilt Angle Range -5 - +32°*
- 2 Backrest Tilt Angle Range 90 - 130°
- 3 Adjustable Seat Depth 450 - 540mm
- 4 Adjustable Seat Width 330 - 530mm
- 5 Arm Height & Depth Adjustability
- 6 Height Adjustable Pocketed Backrest Design 760- 910mm
- 7 Leg Elevation Range 0 - 35°
- 8 Pressure Care Cushion



*Anterior tilt of -5 degree can be achieved with repositioning the tilt gas strut



TAILORED SOLUTIONS WITH POSTUREPRO PLUS

The PosturePro Plus is designed for complex or changing needs. It features a configurable backrest for a more tailored fit and includes additional features beyond the PosturePro model.



Enhanced Postural Support

Adjustable Head, Neck, and Shoulder Sections
Supports users with complex postures, such as kyphosis or fixed contractures. Adjustable sections allow for more tailored support. Ideal for individuals with advanced positioning needs.

Greater Adjustability for Progressive Conditions

Designed to adapt over time, making it suitable for users with progressive conditions or changing needs. As postural needs change, the chair can be adjusted to offer higher levels of support.

Negative Angle Leg Rest

Includes a leg rest that accommodates contractures, providing necessary support for users with specific leg positioning needs.

Pocketed Waterfall Design with Enhanced Customisation

The PosturePro Plus offers greater flexibility with adjustable height and lateral angles. Padding in individual backrest elements can be added or removed to suit the user's shape and postural needs.

CLINICAL CONSIDERATIONS

Older adults and individuals with progressive health conditions will benefit from PosturePro's support and adjustability. It is ideal for those with neurological conditions like multiple sclerosis, motor neuron disease, Parkinson's, or dementia. It also supports users with spinal injuries, chronic pain, or reduced mobility.

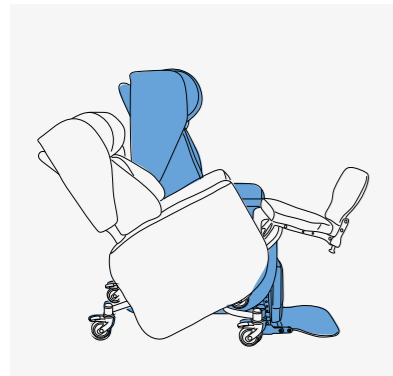

Improved postural positioning to support

- Pressure care management
- Users with low tone or postural deviations; achieved through full body support and use of TIS, recline and leg elevation to counter gravity forces
- Breathing
- Feeding, drinking and swallowing
- Communication
- Sight line for users with kyphotic postures
- Meaningful occupational activities and social engagement
- Relaxation and fatigue management

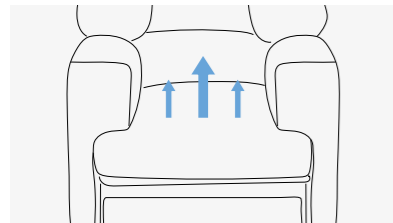

Pressure redistribution and pressure care support

- Tilt and recline functions
- Breathable, multi-stretch fabric on all support surfaces
- A combination of immersive memory foam and air bladders
- Customisable support surfaces (head, back, seat, arm, leg and feet) to promote optimal posture and minimise shear and pressure forces



Carer Support and reduced manual handling

- Ability to change the user's posture without returning them to bed
- Use of chair functions to assist with positioning for different activities
- Large wheels to enable easier transport of user to different environments
- Compatibility for use with active lifters and transporter aids
- Tilt in space and recline to support positioning and use of a full hoists and ceiling hoists
- Gas strut for easy use of tilt and recline functions

PRESSURE MAPPING

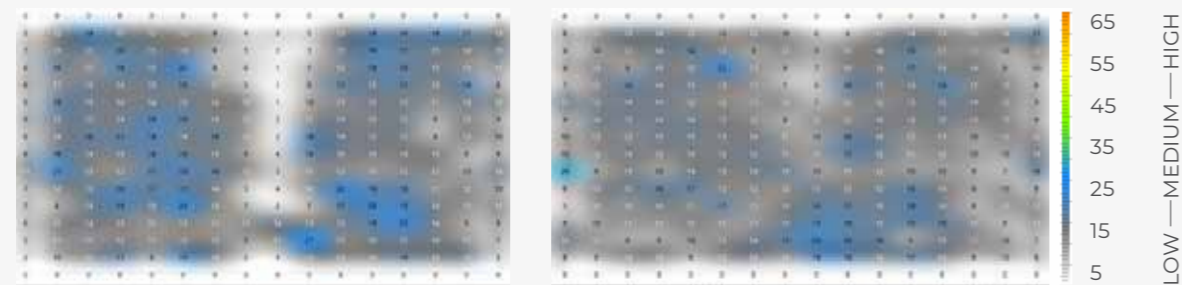

PATIENT A 64kg | 165cm

PATIENT B 110kg | 182cm

mmHg

*The pressure mapping scale is set to accurately perform with respect to the clinically recognised 32mmHg average capillary closing pressure. Clinicians should always ensure pressure mapping scale is set to accurately represent true performance.

PERFORMANCE ENHANCING ACCESSORIES

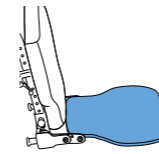

Footrest Padding
CHP231650

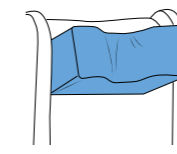

Concave Pillow
CHP231660

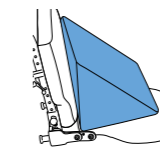

Legrest Wedge
CHP231670

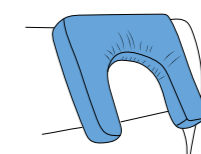

Horse Shoe Pillow
CHP231680

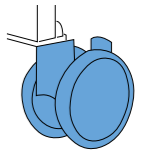

Dual Castor
CHP231690

TECHNICAL SPECIFICATIONS

DIMENSIONS

	CHP231600 PosturePro	CHP231610 PosturePro PLUS
A Seat Depth Range	450 - 540	450 - 540
B Seat Width	330 - 530	330 - 530
C Seat to Foot Plate	530 - 590	530 - 590
D Backrest Height	770	777 - 900
E Overall Height	1300 - 1360	1111 - 1400
F Overall Width	650 - 850	650 - 888
G Overall Depth	950	950

TILT & RECLINE RANGE		
H Backrest Tilt Angle Range	90 - 130	90 - 130
I Seat Tilt Angle Range	-5 - +32	-5 - +32
J Leg Elevation Range	0 - 35	0 - 35

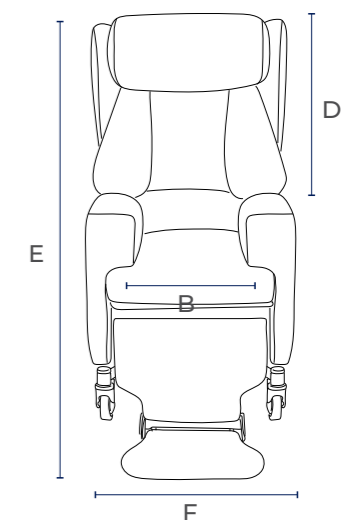
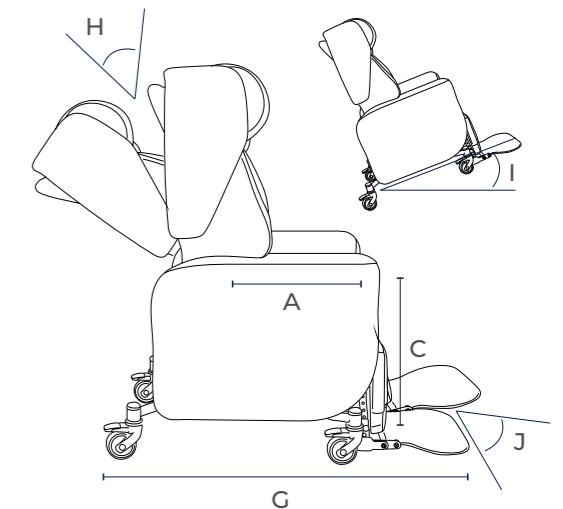

2 YEARS WARRANTY
Frame

1 YEAR WARRANTY
Components & Fabric

SWL
140kg



ASBR409 171924