



AIR LIFT CHAIR

USER MANUAL



Thank you for choosing the Aspire Air Lift Chair.

This chair has been specifically designed to offer comfort, support and safety.

It is important that you read this user manual carefully before using your new Air Lift Chair.

TABLE OF CONTENTS

Symbols & Label Information	4
Label Information	5
1. Introduction	6
2. General Guidelines	7
3. Your Air Lift Chair	10
4. Air Lift Chair Set Up	13
5. Operation	16
6. Troubleshooting	21
7. Care And Maintenance	23
8. Warranty	25
Specifications	26
Appendix	26

SYMBOLS & LABEL INFORMATION

The symbols below are used throughout this owner's manual and on the product to identify warnings and important information. It is very important for you to read them and understand them completely.



WARNING! Indicates a potentially hazardous condition/situation. Failure to follow designated procedures can cause either personal injury, component damage or malfunction. On the product, this icon is represented as a black symbol on a yellow triangle with a black border.



MANDATORY! These actions should be performed as specified. Failure to perform mandatory actions can cause personal injury and/or equipment damage. On the product, this icon is represented as a white symbol on a blue dot with a white border.



PROHIBITED! These actions are prohibited. These actions should not be performed at any time or in any circumstances. Performing a prohibited action can cause personal injury and/or equipment damage. On the product, this icon is represented as a black symbol with a red circle and red slash.

Please fill out the following information for quick reference:

Aspire Dealer	
Address	
Phone Number	
Purchase Date	
Serial Number	

NOTE: This owner's manual is compiled from the latest specifications and product information available at the time of publication. We reserve the right to make changes as they become necessary. Any changes to our products may cause slight variations between the illustrations and explanations in this manual and the product you have purchased. The latest/current version of this manual is available on our website.

LABEL INFORMATION

PRODUCT SAFETY SYMBOLS

The symbols below represent labels used on the product to identify warnings, mandatory actions and prohibited actions. It is very important for you to read and understand these symbols completely. Do not remove these labels from your product. Please note that not all of the symbols may be used on your lift chair model.



Electrical hazard



Maximum weight capacity



Read and follow the information in the owner's manual.



Do not connect an extension lead to the AC/DC converter or the battery charger



Pinch/crush points hazard! Do not place objects or appendages in the path of moving parts



Do not place objects under the lift chair. Make sure the area is clear of obstructions, including pets and small children during operation



Removal of grounding prong can create electrical hazard. If necessary, properly install an approved 3-pronged adapter to an electrical outlet having 2-pronged plug access



Properly dispose of all electronic components, including the external transformer, hand control, batteries, actuator motors and wiring. Contact your authorised aspire dealer for more information



Battery door location



Class II equipment



Green LED indicates power to the unit is on. Not applicable to all models



Degree of protection against electric shock



This product has been tested and complies to IEC 60601-1-2



Indoor use only. Avoid exposure to rain, snow, ice, salt or standing water. Maintain and store in a clean and dry environment



Do not place objects under the footrest when the lift chair is in the fully reclined position. Make sure area is clear of obstructions, including pets and small children during operation



Do not cover or place the external transformer under the riser recliner. Keep in an open, well-ventilated area free from foreign material and away from possible pinch points

1. INTRODUCTION

SAFETY

CONGRATULATIONS on purchasing your Aspire Air Lift Chair. The product you have purchased combines state-of-the-art components with **safety**, comfort and styling in mind. We are confident the design features will provide you with the conveniences you expect during your daily activities. Understanding how to **safely** operate and care for this product should bring you years of trouble-free operation and service.

Read and follow all instructions, warnings and notes in this manual and all other accompanying literature before attempting to operate this product for the first time. In addition, your **safety** depends upon you, as well as your dealer, carer or healthcare professional in using good judgement.

If there is any information in this manual which you do not understand, or if you require additional assistance for setup or operation, please contact your authorised Aspire Dealer. **Failure to follow the instructions, warnings and notes in this manual and those located on your Aspire product can result in personal injury or product damage and will void the Aspire product warranty.**

PURCHASER'S AGREEMENT

By accepting delivery of this product, you promise that you will not change, alter or modify this product or remove or render inoperable or unsafe any guards, shields or other safety features of this product; fail, refuse or neglect to install any retrofit kits from time to time provided by Aidacare to enhance or preserve the safe use of this product.

INFORMATION EXCHANGE

We want to hear your questions, comments and suggestions about this manual. We would also like to hear about the safety and reliability of your new lift chair and about the service you received from your authorised Aspire Dealer. Please notify us of any change of address, so we can keep you apprised of important information about safety, new products and new options that can increase your ability to use and enjoy your lift chair.

Please feel free to contact us at the address below:

AUSTRALIA

Building 3A, 1 Moorebank Avenue,
Moorebank NSW Australia 2170

1300 133 120 | aidacare.com.au

UK

Arcadia House, Maritime Walk,
Ocean Village, Southampton SO14 3TL
United Kingdom

01622 541235 | aidacare.co.uk

NOTE: If you ever lose or misplace your product registration card or your copy of this manual, contact us and we will be glad to send you a new one immediately.

2. GENERAL GUIDELINES

Your Air Lift Chair is a state-of-the-art life-enhancement device designed to increase mobility and provide pressure relief. Please be aware that the final selection and purchasing decision regarding the type of air lift chair to be used is the responsibility of you, the air lift chair user, if capable of making such a decision, and/or your healthcare professional (i.e. medical doctor, allied health professional, therapist etc.).



MANDATORY! Read and follow the information provided in this owner's manual before attempting to operate your Air Lift Chair for the first time.

There are certain situations, including some medical conditions, where you will need to practise operating the Air Lift Chair in the presence of a trained attendant. A trained attendant can be defined as a family member or healthcare professional specially trained in assisting you with performing various daily living activities while safely operating a lift chair.

Below are some precautions, tips and other safety considerations that will help you become accustomed to operating the Air Lift Chair in a safe manner.

MODIFICATIONS

Aspire chairs are designed and engineered to provide maximum comfort and utility. However, to prevent personal injury and/or damage to your Air Lift Chair, you should not modify, add, remove or disable any feature, part or function of your Air Lift Chair. Unauthorised modifications may also void your product's warranty.

NOTE: Use Aspire approved parts only for all repairs and replacements.

WEIGHT LIMITATIONS

Your Air Lift Chair is rated for a maximum weight capacity. The Aspire Air Lift Chair has a safe working load (SWL) of 140 kg.



MANDATORY! Stay within the specified weight capacity of your Air Lift Chair. Failure to do so may result in injuries and/or product damage, Aidacare will not be held responsible for any such issues/failures.

PINCH/CRUSH HAZARDS

The scissor and lift mechanisms are labeled as pinch/crush point hazards on your Air Lift Chair. Keep clear of these areas and make sure the path of motion is unobstructed. See figure 3.1 for pinch/crush point locations.



WARNING! Do not place objects or appendages in the path of moving parts.

DEGREE OF PROTECTION/MODE OF OPERATION

- Class II equipment/Type B protection against electric shock
- Degree of protection against the ingress of solid/liquids—IPX0
- Mode of operation—Maximum Duty Cycle: 2 min. ON/18 min. OFF

STORAGE AND OPERATION TEMPERATURES

- Transportation or storage: -75°C/-104°F to 70°C/158°F
- Operation: 10°C/50°F to 40°C/104°F

ELECTROMAGNETIC AND RADIO FREQUENCY INTERFERENCE (EMI/RFI)



WARNING! Laboratory tests have shown that electromagnetic and radio frequency waves can have an adverse effect on the performance of electrically-powered devices, such as lift chairs.

Electromagnetic and Radio Frequency Interference can come from sources such as cellular phones, mobile two-way radios (such as walkie-talkies), radio stations, TV stations, amateur radio (HAM) transmitters, wireless computer links, Wifi, microwave signals, paging transmitters and medium-range mobile transceivers used by emergency vehicles. In some cases, these waves can cause unintended movement or damage to the control system of electrically-powered devices. The lift chair user can help prevent electromagnetic interference by maintaining a minimum distance between portable and mobile RF communications equipment. It is recommended that at least 3 metres (9 feet) of distance be maintained between the lift chair and any handheld equipment emitting 10W or more of output power. Refer to the manufacturer's literature for the handheld device to determine the maximum output power of that device.

Every electrically-powered device has an immunity (or resistance) to EMI. The higher the immunity level, the greater the protection against EMI. Per EMC standards, this product has passed immunity testing and is rated as a Group 1, Class B product, meaning the lift chair uses RF energy only for its internal function. Therefore, its RF emissions are very low and are not likely to cause any interference in nearby electronic equipment making the lift chair suitable for use in all establishments, including domestic establishments and hospitals.



WARNING! Be aware that cell phones, two-way radios, laptops and other types of radio transmitters may cause unintended movement of your electrically-powered device due to EMI. Exercise caution when using any of these items while operating your lift chair.



WARNING! The addition of accessories or components to the lift chair can increase the susceptibility of the chair to EMI. Do not modify your lift chair in any way not authorised by Aidacare.

WARNING! Your lift chair itself can disturb the performance of other electrical devices located nearby, such as alarm systems.

NOTE: If unintended motion occurs, discontinue use of the Air Lift Chair. Contact Aidacare to report the incident.

SHIPPING AND DELIVERY

Before using your Air Lift Chair, make sure your delivery is complete as some components may be packaged individually. If you do not receive a complete delivery, please contact your authorised Aspire Dealer immediately. Where damage has occurred during transport, either to the packaging or content, please contact the delivery company responsible.

MOTOR VEHICLE TRANSPORT

If you will be transporting your Air Lift Chair in a motor vehicle, individual components (external transformer, etc.) should be secured. The Air Lift Chair itself must also be secured (a possible hazard during vehicle braking).

3. YOUR AIR LIFT CHAIR

BODY COMPONENTS

This section describes the features of your Air Lift Chair. Carefully review the function and location of each item described, and note that the illustrations and option locations shown in this manual may not reflect the type of lift chair that you own.

Space Saver Hand Control



Dual Action Hand Control



Hand Pump – Seating Surface

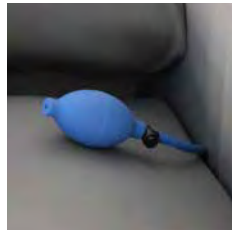

Castors

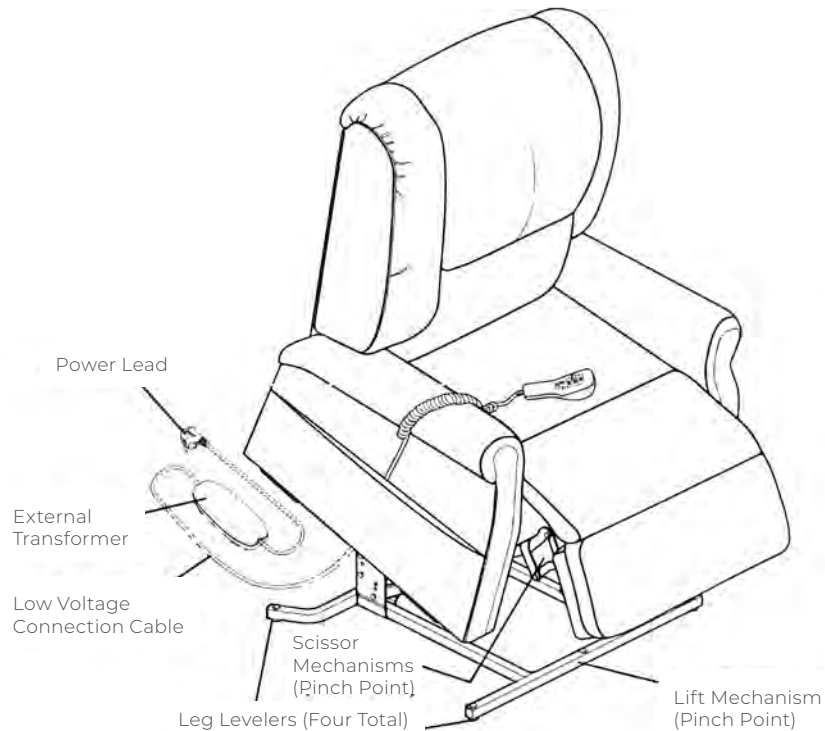

Figure 3.1 Air Lift Chair Main Components

Lift Mechanism: Responds to the hand control commands to position the chair in the sit, recline and stand positions.

Leg Levelers: Manually rotate up or down in order to stabilise the chair before use (Fig. 3.2).

Rotate the leg levelers to raise or lower the chair

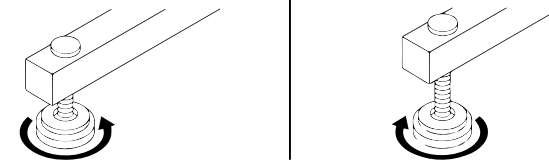

Figure 3.2 Leg Levelers

Mobility Castors: May be installed in addition to the leg levelers to allow users to move and position chair with ease. (Fig. 3.3).



Figure 3.3 Mobility Castors



WARNING! Pinch/Crush Points Hazard! Be aware that the lift mechanism and scissor mechanisms are a pinch point on the air lift chair. Keep the following items and similar objects clear of these points when operating the air lift chair:

- Appendages
- Small children
- Pets
- Wires
- Oxygen tubes
- Loose items, including but not limited to clothing and blankets
- Electrical power leads

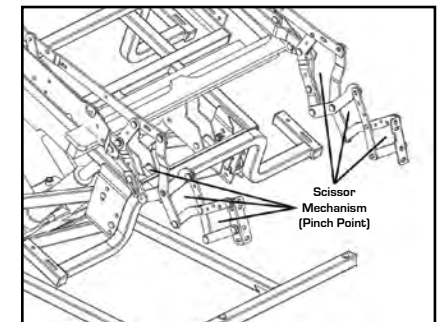

Figure 3.4 Scissor Mechanism

NOTE: Aidacare is not responsible for damage due to improper installation.

ELECTRICAL COMPONENTS

Your Aspire Air Lift Chair is equipped with a low voltage DC motor system that reduces the standard household alternating current of 90V AC – 264V AC to direct current (24/39V DC). The electrical components include the external transformer, batteries and hand control. Keep these areas free from moisture at all times.



WARNING! Keep all electrical components free from moisture at all times to prevent shock and/or electrical hazard.

External Transformer: Connects to a standard electrical outlet to provide power to the air lift chair. The transformer may be equipped with an LED indicator, which shows green when power to the transformer is on.

The external transformer may also come equipped with mounting brackets that allow the transformer to be mounted to the wall directly under the standard electrical outlet. The screws must be mounted to the wall stud for security.

Batteries: Provide the power needed to return the Air Lift Chair to an upright or semi-upright position in the event of a power failure. Batteries are included with the user manual and must be installed into the external transformer. See 4. Air Lift Chair Set Up.

NOTE: The batteries will provide power for only a short period of time after power is removed from the system, so it is important to act quickly in the event of a power failure. Engage and hold the up/down switch in the UP position as soon as possible. Maintain a steady pressure on the switch to avoid excessive draw from the battery and achieve the most amount of lift. Keep in mind that the amount of lift the batteries will be able to provide is affected by user weight and battery condition.

Hand Control: Contains the controls needed to operate the various functions of the lift chair. Refer to 5. “Operation” for more information. The hand control may be equipped with a quick-release connector, which enables the user to detach the hand control from the lift chair, disabling all functions of the hand control.

4. AIR LIFT CHAIR SET UP

LIFT CHAIR PLACEMENT

Your Air Lift Chair should be placed near a standard electrical outlet on dry, level ground where there is ample room to allow for proper operation. It is recommended that you have the assistance of an attendant when positioning the Air Lift Chair to avoid the possibility of injury when lifting.

Follow these steps to position the Air Lift Chair in a safe manner:

1. The back of the Air Lift Chair should be positioned with sufficient clearance to avoid any obstructions, particularly behind the chair after reclining. Suggested clearances by model are:
Space Saver (single motor) – 160mm | Dual Action (dual motor) – 350mm
2. Adjust the leg levelers to stabilise the Air Lift Chair (**Fig. 3.2**), or if desired attach the 4 optional mobility castors.
3. Install the batteries into the external transformer. Refer to “Battery Installation” for more information.
4. Position the external transformer on the floor in an open, well-ventilated area where it will not be an obstruction.
5. Position the low voltage connection cable (cable from transformer to chair), where it will not be pinched between the frame and the lift mechanism.
6. Connect the low voltage connection cable to the external transformer if it is not already connected.
7. Plug the power lead directly into the electrical outlet. Do not use an extension lead!

NOTE: If you discover a problem at any point during the set-up and positioning of your air lift chair, stop and contact your authorised Aspire Dealer immediately. To avoid personal injury and/or product damage, **DO NOT** plug the unit into the electrical outlet until the problem is corrected and do not attempt to fix electrical problems by yourself.

BATTERY INSTALLATION

Your Air Lift Chair may be equipped with a battery backup system that will activate during a power failure. The backup system is powered by two 9V batteries (not included) that need to be installed into the external transformer.

Follow these steps to install the batteries:

1. Unplug the external transformer power lead from the electrical outlet (lead from transformer to wall).
2. Open the marked battery door on the external transformer.
3. Install two 9V batteries into the external transformer (**Fig. 4.2**).
4. Replace the battery door.

NOTE: Always make sure the external transformer is equipped with two fresh 9V batteries. The battery backup system does not recharge itself. Fresh batteries are defined as 9V alkaline batteries that are replaced every time the battery backup system is activated during a power failure, or once a year if the battery backup system has not been activated.

NOTE: If you unplug your air lift chair for an extended period of time (more than one hour), remove the batteries from the external transformer. The air lift chair will draw power from the batteries even when it is not in use.

IDEA: Check 9V battery every year when you check your smoke alarm!

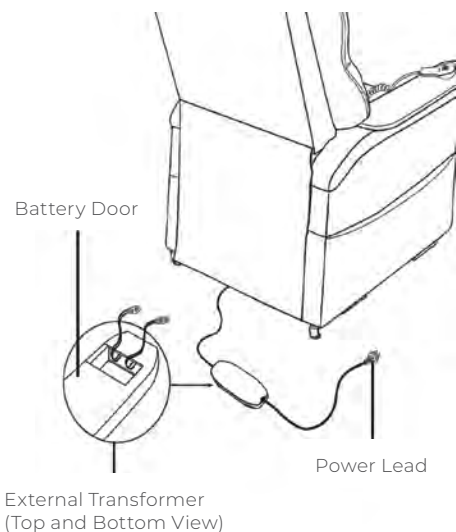

Figure 4.2 Air Lift Chair Battery Backup Location

ADJUST THE SEAT DEPTH

1. Remove the Backrest by releasing the latch on both sides.



2. Unscrew and remove the two screws holding the bracket in place.
3. Remove and re-position the bracket to align with the alternative position.



4. Align the bracket screw holes then, carefully, insert and tighten the two holding screws.
5. Check that bracket is secure and then replace the backrest, making sure the latch clicks into place

5. OPERATION

SAFE OPERATING PRECAUTIONS

There are certain precautions that should be taken during the operation of your Air Lift Chair. Read and follow these precautions carefully in order to ensure safe Air Lift Chair operation and to prevent injury and/or product damage.

- Plug the power lead directly into the electrical outlet. **DO NOT** use an extension lead!
- Ensure the power lead is unplugged before moving the Air Lift Chair
- When transferring a patient on / off the chair, ensure the rear castors are locked (if installed)
- **DO NOT** place anything (e.g. a drinking glass) on top of or near the external transformer.
- If the external transformer box or hand control requires cleaning, unplug the power lead from the electrical outlet and use a clean, dry cloth or lightly dampened cloth. Dry completely before plugging the power lead back into the electrical outlet.
- Periodically check the hand control and all power leads for visible damage.
- Keep the hand control away from all heated surfaces.
- Ensure the hand control is out of the way before sitting in the chair.
- Keep children and pets away from all moving parts while operating the Air Lift Chair.
- **DO NOT** allow children to play on or operate the Air Lift Chair. Only the intended user should operate the air lift chair.
- **AVOID** pinch points, such as the lift and scissor mechanisms. Keep hands and feet clear of these areas.
- **ALWAYS** leave the Air Lift Chair in an upright and closed position when not in use.
- **DO NOT** sit or stand on the legrest.
- **DO NOT** “drop” into the Air Lift Chair when sitting if it is in a partially raised position, this will damage the seating and void warranty.
- **DO NOT** use as a CPR bed



PROHIBITED! Do not place objects under the Air Lift Chair. Make sure area is clear of obstructions, including pets and small children during operation.

WARNING! Prevent the risk of electrical shock, fire, falls and/or being pinched. Follow all instructions and precautions provided.

WARNING! Prevent potential equipment damage!

DO NOT place the external transformer under the Air Lift Chair.



WARNING! Do not cover the external transformer. Keep the transformer in an open, well-ventilated area free from foreign material/debris to ensure proper operation.

HAND CONTROL OPERATION

Depending on lift chair model, the hand control may be equipped with switches that control the movement of the chair-back, chair base and legrest (**Fig. 5.1, 5.2 and 5.3**).



WARNING! Do not lean on or apply downward force to the chair-back when the Air Lift Chair is in the fully reclined position. Doing so could cause the Air Lift Chair to tip, resulting in personal injury and/or product damage.

WARNING! Do not use the legrest as a seat, or for purposes outside its intended use. Doing so could cause instability in the air lift chair and place undue stress on Air Lift Chair components, resulting in personal injury and/or product damage.

WARNING! Be sure to lock or disconnect the hand control when the Air Lift Chair is not in use.

WARNING! The hand control is not waterproof and should not be washed or put in liquid

SPACE SAVER HAND CONTROL OPERATION

Follow these steps to sit in your Air Lift Chair (**Fig. 5.1**):

1. Engage and hold the **Stand Position** button to raise your Air Lift Chair to the standing position.
2. Back into the Air Lift Chair and sit in the centre of the seat, using the armrests for support if needed.
3. Engage and hold the **Recline Position** button to lower the Air Lift Chair to a comfortable seated position.

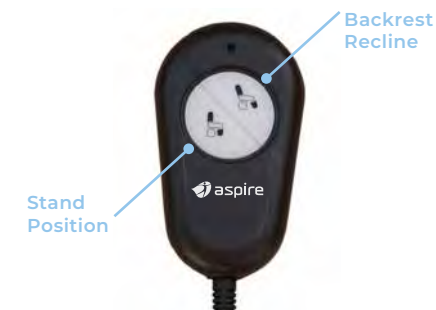

Figure 5.1 Space Saver Hand Control

Follow these steps to recline your Air Lift Chair from the seated position (**Fig. 5.1**):

1. Engage the **Recline Position** button and hold down until comfortably reclined.
2. Engage and hold the **Stand Position** button to return to an upright, seated position. Release the button when the Air Lift Chair reaches a comfortable seated position.

Follow these steps to stand up from your Air Lift Chair (Fig. 5.1):

1. Engage and hold the Stand Position button to raise your Air Lift Chair.
2. Release the button when the Air Lift Chair reaches a height where you can stand up comfortably.

NOTE: The hand control on your Air Lift Chair may be equipped with an LED that indicates power to the hand control.

If this LED is present and not lit when the hand control is in use, contact your authorised Aspire Dealer.

DUAL ACTION HAND CONTROL OPERATION

Follow these steps to sit in your lift chair (Fig 5.2):

1. Ensure the chair back is raised by engaging the Backrest Raise button and the legrest is down by engaging the Legrest Down button.
2. Engage and hold the Stand Position button to raise the chair to the standing position.
3. Back into the chair and sit in the centre of the seat, using the armrests for support if needed.
4. Engage and hold the Seated Position button to lower the chair to a comfortable seated position.

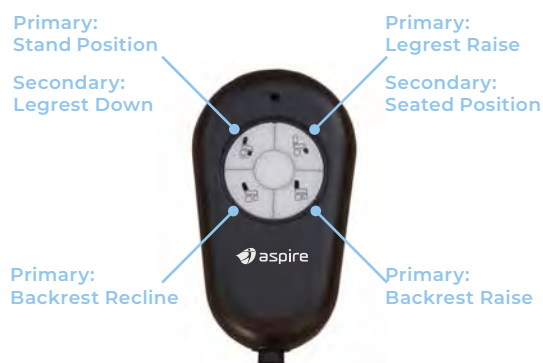

Figure 5.2 Dual Action Hand Control

Follow these steps to recline your Air Lift Chair from the seated position (Fig. 5.2):

1. Engage and hold the Backrest Recline button until comfortably reclined. Engage and hold Backrest Raise button to raise chair back up.
2. Engage and hold the Legrest Raise button until a comfortable leg position is reached. Engage and hold the Legrest Down button to lower the legrest back down.

Follow these steps to raise or lower your legrest while in the seated or reclined position (Fig. 5.2):

1. Engage and hold the **Legrest Raise** button until a comfort leg position is reached.
2. Engage and hold the **Legrest Down** button to lower the legrest back down.

Follow these steps to stand up from your Air Lift Chair (Fig. 5.2):

1. Ensure the chair back is raised by engaging the **Backrest Raise** button and the legrest is down by engaging the **Legrest Down** button.
2. Engage and hold the **Stand Position** button to raise the chair to the Standing Position.
3. With your feet firmly on the ground stand slowly out of the chair, using the armrests for support if needed.

NOTE: The Primary or Secondary functions automatically override depending on the current position of the chair

MOBILITY CASTORS

All Aspire Air Lift Chairs come with four genuine Tente mobility castors. The two rear castors are locking. To lock the rear castors, push the lever to 'ON'. To unlock the castors, push the lever to 'OFF' (Fig. 5.3):



Figure 5.3 Mobility Castors

6. TROUBLESHOOTING

MODULAR PRESSURE RELIEF SYSTEM – ADJUSTABLE

- This product is designed to redistribute pressure areas and provide the user with comfort. It comprises of a pressure adjustable air bladder in the seating surface and lumbrosacral contouring in the backrest.
- The adjustable air bladder can be adjusted via a hand pump to suit the needs of the individual.
- It is recommended to inflate the air bladder prior to the user sitting in the chair.
- To inflate the air bladder, use the hand pump located within the chair. As a guide 50 full pumps without a user in the chair will bring the air bladder to 'firm pressure'.
- The carer or user should release pressure by pressing the release button on the hand pump, until the desired softness and immersion is achieved.
- The pressure should be checked and adjusted weekly.
- The user should never be able to feel any hard frame surfaces under the seat or backrest if correctly inflated.
- **NOTE:** Always bear in mind that an appropriate amount of immersion and envelopment is required for pressure re-distribution, relief and comfort.
- The user should always have maximum immersion and envelopment without losing the support of the chair.

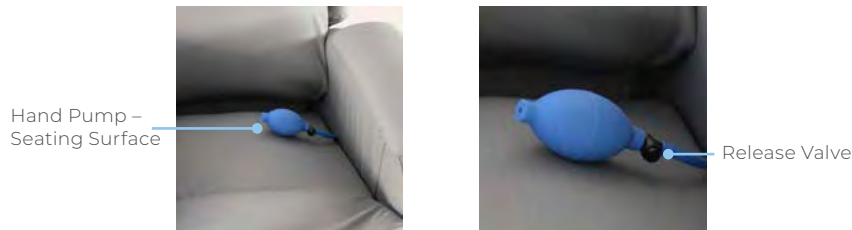

Figure 5.4 Modular Pressure Relief System – Adjustable

Your Air Lift Chair is a state-of-the-art product designed to enhance your mobility whilst providing postural support and high level pressure relief. Your air lift chair should bring you years of trouble-free service, however, it may require occasional troubleshooting. The following troubleshooting tips and FAQs should summarise what you need to know about your air lift chair. If at any time you do not feel comfortable performing the troubleshooting steps listed in this manual, contact your authorised Aspire Dealer for service. Please have the model number, serial number and nature of the problem when calling.

FREQUENTLY ASKED QUESTIONS

What if my Air Lift Chair does not operate at all?

- Ensure the external transformer is plugged into a properly wired electrical outlet.
- Check the circuit breaker box connected to the electrical outlet to ensure the outlet is receiving power.
- Ensure the low voltage connection cable is plugged into the external transformer.
- Ensure that all cables are connected properly.
- Check all cables for signs of damage (cuts, flattened areas).

What if my Air Lift Chair operates in one direction only?

- Check the up and down buttons or toggle switch on the hand control to make sure they do not stick. If the buttons or switch are sticking in either position, the hand control may need to be replaced.
- Contact your authorised Aspire Dealer for further assistance.

What if my Air Lift Chair stops during a lifting cycle?

- Your Air Lift Chair is equipped with an internal thermal shutoff switch located inside the external transformer that prevents the motor control box from overheating. If the thermal shutoff activates, allow the air lift chair to remain in a stationary position for 10 minutes to allow the motor to cool, then resume normal operation. If you notice the motors overheating frequently, contact your authorised Aspire Dealer.
- There may have been a power failure and/or there are no batteries in the external transformer or the batteries have no charge. Always make sure there are fresh 9V batteries in the external transformer if equipped with battery backup.
- Check the circuit breaker box connected to the electrical outlet.

7. CARE AND MAINTENANCE

What if my air lift chair is rocking from corner to corner after I position the chair?

The floor may be uneven or the carpet may be affecting chair position. Adjust the leg levelers in the area where the chair is rocking. See III. "Your Air Lift Chair" for instructions on leveling your chair.

Where can I place the external transformer box?

- On the floor away from heat sources in an open, well-ventilated area where it will not be an obstruction.

What do I do if there isn't enough air in the chair?

- It is important that the user gets enough immersion and envelopment in the chair in order to get optimal pressure re-distribution. Therefore it may seem that there is decreased air in the bladder within in the seating surface if a user is not in the chair.
- The best way to correctly adjust your Air Lift Chair is as per the directions in 5. Operation – Modular Pressure Relief System – Adjustable. However, if you believe that there is not enough air due to a fault, un-velcro the Air Lift Chair's seating surface cover and carefully remove the air bladder.
- Check for any signs of damage or punctures to the valve or bladder. This is most easily done by immersing the bladder in water whilst inflated. Apply pressure to the bladder and air bubbles will arise at the source of any leaks.
- Contact Aidacare for repair or a replacement air bladder

Where do I find the serial number on my Air Lift Chair?

You can find the serial number in two locations—one is near the rear of the motor on the steel lift mechanism, and the second is attached to the frame below the scissor mechanisms. The model number for your lift chair is printed below the serial number bar code.

Who do I call for service?

Contact your authorised Aspire Dealer for service.

Your Air Lift Chair will require routine maintenance checks. You can perform some of these checks, but others may require assistance from an authorised Aspire Dealer. By following the maintenance checks in this section as scheduled, you can help ensure your air lift chair gives you years of trouble-free operation. If you have any questions regarding your air lift chair's care, contact your authorised Aspire Dealer.

FABRIC CARE

The materials used for your Air Lift Chair's upholstery are resistant to most everyday environmental factors. They will remain in good condition if they are regularly maintained (at least once per month).

To do this:

- Regularly dust and clean
- Use soapy water and then rinse with clean water (not excessively)
- Remove all stains as quickly as possible
- Regularly remove sweat marks
- Avoid prolonged exposure to any heat source
- **DO NOT** use undiluted alcohol, solvents, detergents, corrosive cleaning products, perchlorethylene, waxes, trichloroethylene
- **DO NOT** use hard brushes or any other pointed object to clean the DARTEX cover
- To remove any stubborn stains, use bleach or 10% alcohol diluted in water. Rinse with clean water (not excessively)
- Some stains can be reduced, though not removed, after cleaning. These include: ink, coffee, wine, alcohol, blood, urine, food, chocolate, ketchup etc. and some colourants used in clothing such as jeans. Aidacare is not liable for residual stains resulting from outside pollutants.
- If used for multiple patients, the Aspire Air Lift Chair should be cleaned and disinfected after each use





WARNING! Fabric should not be allowed to come in direct contact with any type of heat source (e.g. a space heater or cigarette). Personal injury or fire damage may occur.

WARNING! It is strongly recommended that you do not smoke cigarettes while seated in or using your lift chair, although the lift chair has passed the necessary testing requirements for cigarette smoking. You must adhere to the following safety guidelines if you decide to smoke cigarettes while seated in or using your lift chair.



- **DO NOT** leave lit cigarettes unattended.
- **KEEP** ashtrays a safe distance from the lift chair.
- **ALWAYS** make sure cigarettes are completely extinguished before disposal.

NOTE: DO NOT use solvent-type cleaners to spot clean. **DO NOT** saturate the fabric. Prevent damage to the fabric; **DO NOT** expose the lift chair to direct sunlight.

ELECTRONICS CARE

- Inspect all wiring harnesses to make sure they are not damaged or frayed.
- If damage is present, unplug the air lift chair and contact your authorised Aspire Dealer for service.
- Keep all electronics free from moisture and temperature extremes. Air Lift Chairs are intended for indoor use only!



WARNING! Even though the air lift chair has passed the necessary testing requirements for ingress of liquids, you should keep electrical connections away from sources of dampness, including direct exposure to water or bodily fluids and incontinence. Check electrical components frequently for signs of corrosion and replace as necessary.

WARNING! Plastic bags are a suffocation hazard. Dispose of plastic bags properly and do not allow children to play with them.

8. WARRANTY

TWO-YEAR LIMITED WARRANTY

For two (2) years from the date of purchase, Aidacare will repair or replace at our option to the original purchaser, parts found upon examination by an authorised representative of Aidacare to be defective in material and/or workmanship.

• Steel Frame • Motor • Hand Control • Scissor Mechanisms • Steel Lift Mechanism

NOTE: Aidacare reserves the right to replace only the part of the steel lift mechanism that may be defective. Aidacare provides parts only under warranty. Your Aspire Dealer is responsible for labour and service. Please contact your Aspire Dealer for information about these services and for any applicable charges.

TWO-YEAR FABRIC WARRANTY

Aidacare guarantees to replace any fabric that is found to be faulty as a result of manufacturing defect and which has been used in accordance with our manufacturer performance ratings and care instructions.

An evaluation of fabric related issues must be conducted before confirmation of warranty coverage can be verified.

CONSUMER WARRANTY AGAINST DEFECTS:

Aidacare is bound by Australian Consumer Law in respect to Warranty Against Defects. A copy of the Aidacare Warranty Against Defects statement is available on the Aidacare homepage at aidacare.com.au. All warranty matters should be directed to Aidacare Customer Service on 1300 133 120.

Aidacare does not warrant against excessive or incorrect use, modification or any situation that could not be deemed as fair wear and tear. This is a back to base warranty and does not cover freight costs pertaining to the return of any items under warranty. Aidacare acknowledges and conforms to all ACCC guidelines around consumer rights. For further information contact Aidacare on; 1300 133 120 or email product@aidacare.com.au.

Aidacare will not warrant the safety and or correct functioning of products where any original components have been changed or modified by non-Aidacare approved and trained service & maintenance staff or external providers. Furthermore, safety is not guaranteed where components have been replaced with non-original Aidacare approved parts. If any faults are detected upon receipt of this product please phone Aidacare. Any faults that are detected during normal use should be reported to Aidacare immediately to determine if warranty conditions apply and if so, the necessary repair or replacement work to be completed.

Spare parts list is available upon request.

SPECIFICATIONS

	Seat Height (mm)	Seat Depth (mm)	Seat Width (mm)	Seat To Top Of Back (mm)	Overall Height (mm)	Overall Depth (mm)	Overall Width (mm)	Distance From Wall (mm)	User Height Guide (inches)	SWL (kg)
CHP198865 Space Saver – Petite	480	460	450	610	980	950	680	80	5'0" – 5'6"	140
CHP198870 Space Saver – Large	480	510	510	610	980	980	680	80	5'0" – 5'6"	140
CHP198875 Dual Action – Petite	480	460	450	610	980	950	680	350	5'7" – 6'2"	140
CHP198880 Dual Action – Large	480	510	510	610	980	980	680	350	5'7" – 6'2"	140

APPENDIX

Air Lift Chair Weight Capacity

Model Number	Rated Weight Capacity
Space Saver	140kg
Dual Action	140kg



MANDATORY! Stay within the specified weight capacity of your lift chair. Exceeding the weight capacity voids your Air Lift Chair warranty.

AIDACARE PTY LTD

Building 3A, 1 Moorebank Avenue,
Moorebank NSW Australia 2170

1300 133 120 | aidacare.com.au

AIDACARE LIMITED

Arcadia House, Maritime Walk,
Ocean Village, Southampton SO14 3TL
United Kingdom

01622 541235 | aidacare.co.uk

MADE IN PRC

ASUM16.11160523

