

A close-up photograph of a middle-aged man with grey hair and a beard, wearing a white hospital gown with blue polka dots. He is holding a bright green strap with both hands, looking off to the side with a focused expression. The background is a blurred hospital setting with medical equipment.

Baxter

LIK0

SAFE TRANSFERS AND MOVEMENT PROGRAMME

Slings for Patient Needs

Exclusively distributed by

 **aidacare**
HEALTHCARE EQUIPMENT

CONTENTS

HOW TO APPLY THE SEATED SLING	4
LIKO UNIVERSAL SLING	6
LIKO SOFT ORIGINAL HIGHBACK SLING	7
LIKO ORIGINAL HIGHBACK SLING	8
LIKO COMFORTSLING PLUS	9
LIKO ULTRASLING	10
LIKO MASTERVEST	11
LIKO LIFTPANTS	12
LIKO ULTRA LIFTPANTS	13
LIKO SUPPORTVEST	14
LIKO SAFETYVEST	15
LIKO COMFORTVEST	16
LIKO HYGIENEVEST	17
LIKO MULTISTRAP	18

SUPPORTING YOU EVERY STEP OF THE WAY

SAFE TRANSFERS AND MOVEMENT PROGRAMME (STAMP)

When smart solutions are backed by clinical evidence, better outcomes are possible. That's why we help providers like you implement evidence-based clinical programs focused on early mobility, falls prevention, skin safety and more.

With our Safe Transfers and Movement Program, our clinical experts will help you develop and implement a safe patient handling and mobility program, and we'll back it up with any support and training you may need along the way.

HOW TO APPLY THE SEATED SLING

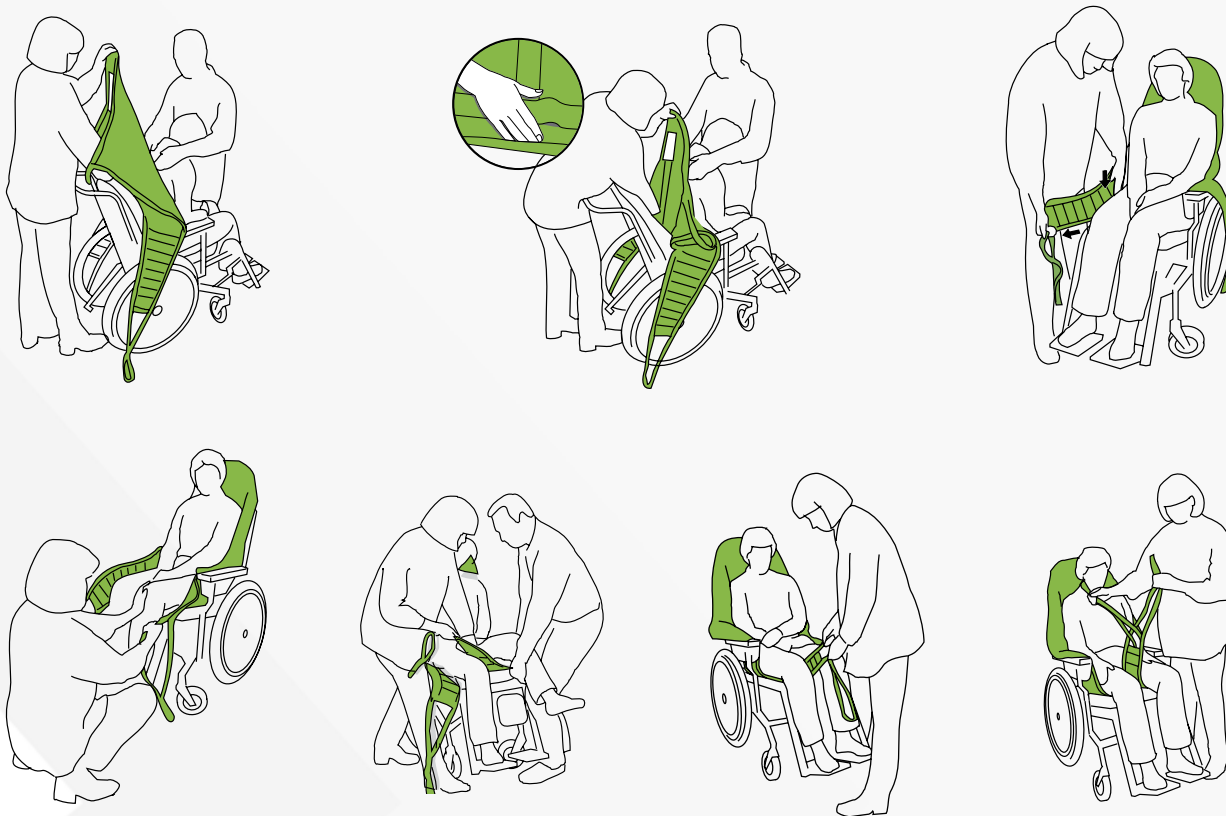

OPTION 1

- Elevate head of bed to sitting position
- Have patient lean forward, or assist as necessary
- Slide sling behind patient until bottom edge of sling reaches the patient's tailbone
- Bring leg supports to side of patient
- Slide leg support underneath patient thigh and crisscross the straps
- Connect shoulder straps first, then the leg straps
- Leg straps may be configured in 3 different applications (please note that alternative 1 is the most common and that alternative 2 and 3 require more indepth knowledge about the patient, the sling and how an alternative application of the leg supports will affect the sling and position of the patient):
 - 1) crisscross leg straps to keep hips in normal alignment
 - 2) connect each leg support without crossing straps to support hip abduction or for patients with sensitive genitals
 - 3) overlap straps under thighs to create a hammock- style support for amputee or to maintain hip adduction
- Before the patient is lifted from the underlying surface, but after the straps have been fully extended, make sure the straps are properly connected to the sling bar

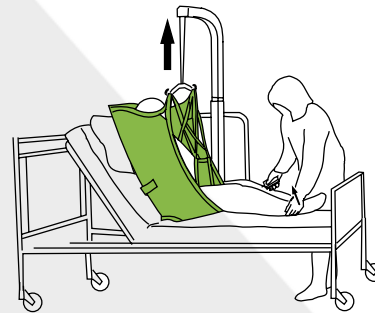
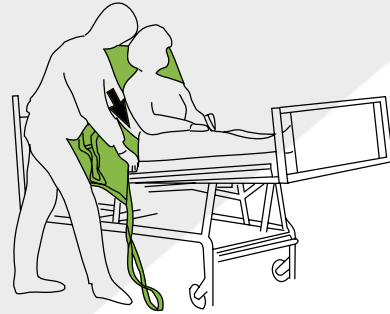
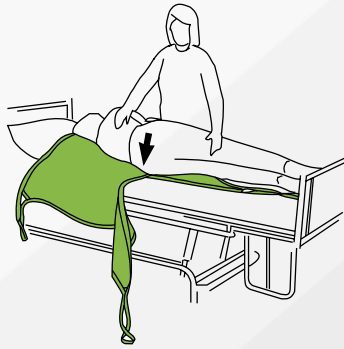

OPTION 2

- Logroll patient onto his or her side
- Fanfold half of sling material under the patient
- Return to supine position and pull out folded sling material
- Slide leg supports underneath patient's thighs and crisscross the straps
- Raise head of bed after the sling is applied
- Connect shoulder straps first, then the leg straps
- Leg straps may be configured in 3 different applications (please note that alternative 1 is the most common and that alternative 2 and 3 require more indepth knowledge about the patient, the sling and how an alternative application of the leg supports will affect the sling and position of the patient):
 - 1) crisscross leg straps to keep hips in normal alignment
 - 2) connect each leg support without crossing straps to support hip abduction or for patients with sensitive genitals
 - 3) overlap straps under thighs to create a hammock-style support for amputee or to maintain hip adduction
- Before the patient is lifted from the underlying surface, but after the straps have been fully extended, make sure the straps are properly connected to the sling bar

LIKO UNIVERSAL SLING

Models: 000/002 SIZES:

S – 35 kg - 55 kg **MS** – 40 kg - 70 kg **M** – 50 kg - 90 kg
L – 80 kg - 120 kg **XL** – >110 kg

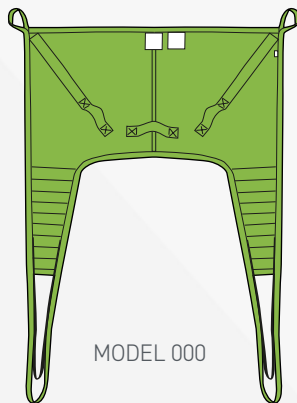

Medium - LSS394775
Large - LSS394774
XLarge - LSS394773



FEATURES

- Good basic sling model for most lifting needs
- Provides back support up to neck level
- Enables an upright sitting position
- Durable polyester, net polyester, and plastic-coated net
- Latex free
- Model 002 (high level) allows extra lifting height due to shorter loop straps; allows patients to sit more upright

CLINICAL APPLICATIONS AND CONSIDERATIONS

Seated slings may be used for transfers to/from bed to chair/commode/stretchers/exam table and picking up from floor (requires manual head support).

- Ensure patients can tolerate a semireclined seated position before procedure begins
- Select the correct-size sling based on patient weight and body type



LIKO SOFT ORIGINAL HIGHBACK SLING

Model: 26 SIZES:

MS – 30 kg - 50 kg **M** – 40 kg - 80 kg **L** – 70 kg - 120 kg
XL – 110 kg - 250 kg **XXL** – >200 kg

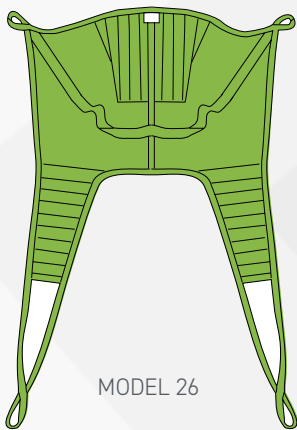

MODEL 26

Medium Slim - LSS394560
Medium - LSS394570
Large - LSS394580
XLarge - LSS394590
XXLarge - LSS394600



FEATURES

- Good basic sling model for most lifting needs
- Provides support up to head level for patients with poor head control
- Enables an upright sitting position
- Durable polyester fabric
- Latex free

CLINICAL APPLICATIONS AND CONSIDERATIONS

Seated slings may be used for transfers to/from bed to chair/commode/stretcher/exam table and picking up from floor.

- Ensure patients can tolerate a semireclined seated position before procedure begins
- Select the correct-size sling based on patient weight and body type

LIKO ORIGINAL HIGHBACK SLING

Models: 25 SIZES:

MS – 30 kg - 50 kg **M** – 40 kg - 80 kg **L** – 70 kg - 120 kg

XL – 110 kg - 250 kg **XXL** – >200 kg

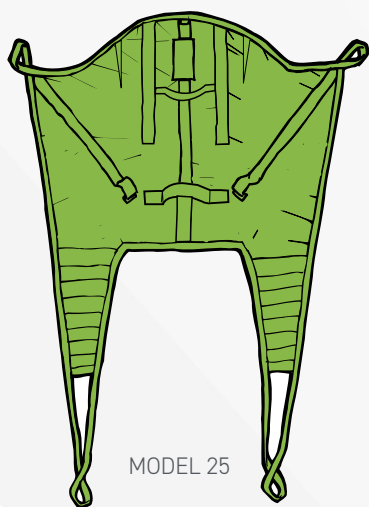

Medium Slim - LSS394560

Medium - LSS394570

Large - LSS394580

XLarge - LSS394590

XX-Large - LSS394600

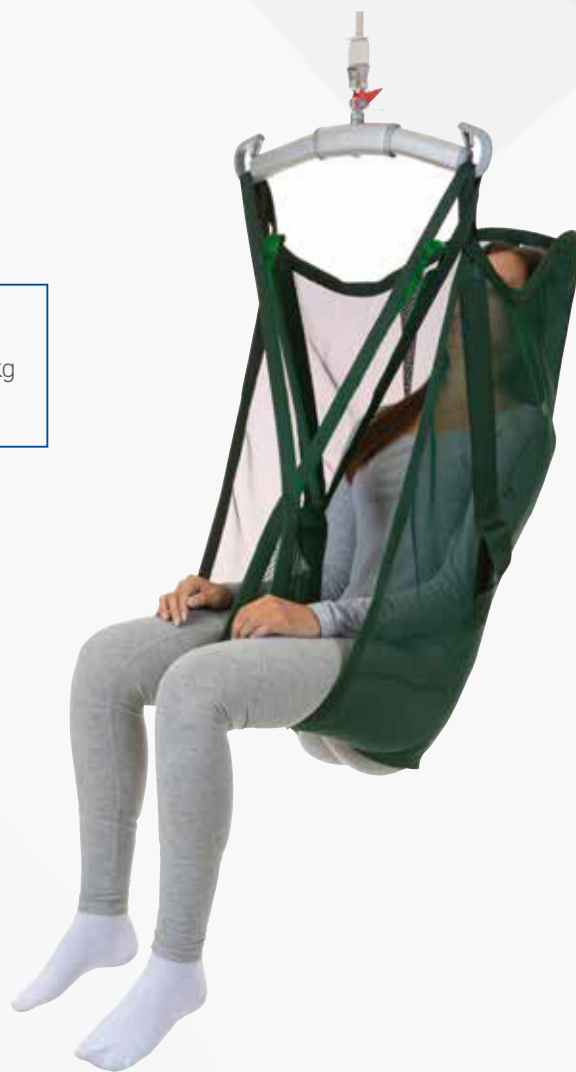

FEATURES

- Good basic sling model for most lifting needs
- Provides support up to head level for patients with poor head control
- Enables an upright sitting position
- Available in net polyester, plastic-coated net and single patient-use fabric (Mod. 25)
- Latex free
- Includes removable plastic laths (not Mod. 25) to support form and shape of sling

CLINICAL APPLICATIONS AND CONSIDERATIONS

Seated slings may be used for transfers to/from bed to chair/commode/stretcher/exam table and picking up from floor.

- Ensure patients can tolerate a semi-reclined seated position before procedure begins
- Select the correct size sling based on patient weight and body type



LIKO COMFORT SLING PLUS

Models: 300/310 and 350/360 (High Back Styles)

M – 40 kg - 80 kg **L** – 70 kg - 110 kg **XL** – > 100 kg

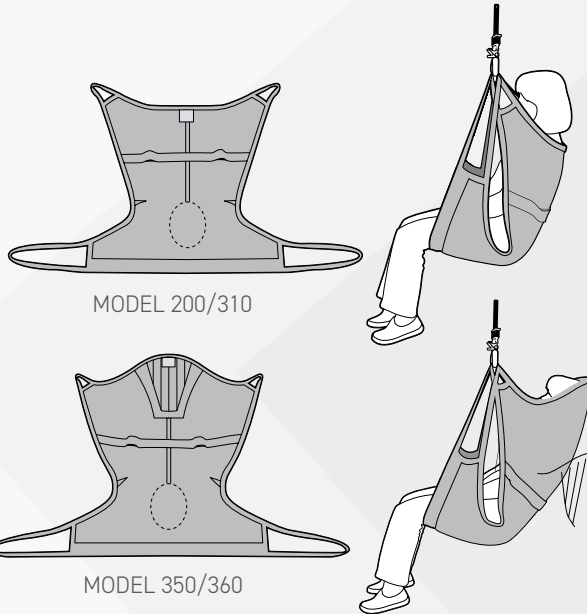

Plus 300 - Medium - LSS394737
Plus 300 - XLarge - LSS394736
Sling 350 - Large - LSS394720
Sling 350 - XLarge - LSS394730



FEATURES

- Upright, full-seated, hammock-type sling
- Should be applied in side-lying position
- Arms are supported inside the sling
- The lower edge of the sling should be just below the bend in the patient's knees (once the patient is lifted the sling's lower edge will be placed approximately 0-10 cm above the bend in the knees)
- Net polyester fabric. Some models also in plastic coated net
- Latex free

CLINICAL APPLICATIONS AND CONSIDERATIONS

Seated slings may be used for transfers to/from bed to chair/commode/stretcher/exam table and picking up from floor. Good for high-disarticulation amputees and patients who suffer from painful joints, are pressure sensitive or have limited range of motion.

- Enables an open angle of the hips when used with the 4-point sling bar
- May be left under patients in limited situations based on skin integrity assessment
- Contraindicated with patients who exhibit spasticity
- Ensure patients can tolerate a semireclined seated position before procedure begins
- Select the correct-size sling based on patient weight and body type



LIKO ULTRASLING

Model: 06

Sizing guidance can be found in the instruction guide for the sling. For the **UltraSling**, these are based on the patient's need for lower leg support and the degree of hip and knee flexion.

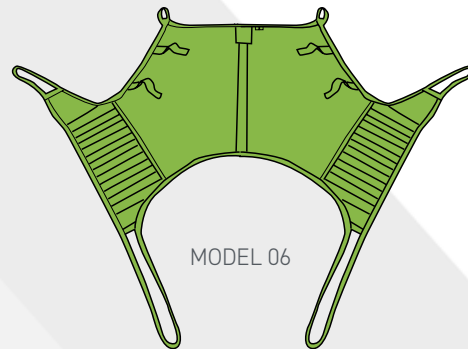
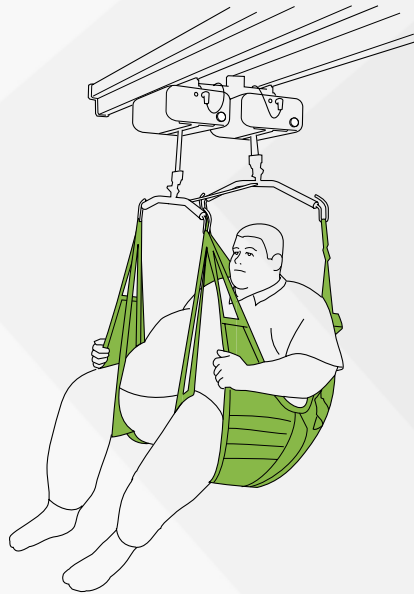

MODEL 06

LSS394410

FEATURES

- Designed for bariatric patients
- Durable polyester fabric
- Latex free

CLINICAL APPLICATIONS AND CONSIDERATIONS

Seated slings may be used for transfers to/from bed to chair/commode/stretcher/exam table and picking up from floor.

- Separate bilateral leg supports accommodate larger, wider thighs
- Tilt-in space feature positions patients for optimal comfort and reduces respiratory concerns due to pannus
- Consider hip and knee range of motion: Select Ultra Short if patients are apple shaped and have good knee flexion
- Select Ultra Regular if patients have reduced knee flexion
- Select Ultra Long if patients are pear shaped and have less or no knee flexion

LIKO MASTERVEST

Model: 60 SIZES:

M – 60 kg - 80 kg **L** – 80 kg - 100 kg

XL – 100 kg - 130 kg **XXL** – >120 kg

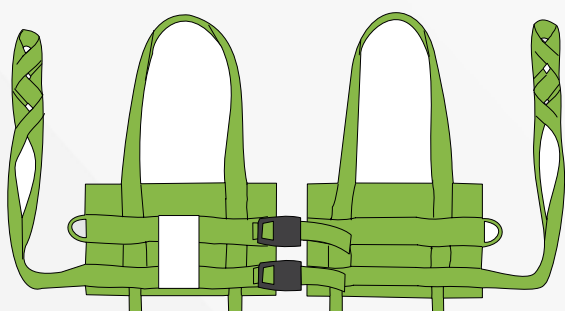

MODEL 64

Small - LSS394260
Medium - LSS394270
Large - LSS394280
XLarge - LSS394290
XXLarge - LSS394300

FEATURES

- Durable polyester fabric
- Latex free
- Buckle front closure provides additional adjustment and comfort around bust and girth
- Designed for patients who can bear weight
- Optional leg harness holds vest in place and prevents sliding up under the arms if needed

CLINICAL APPLICATIONS AND CONSIDERATIONS

The **MasterVest** provides a sense of security for patients. It also provides opportunity for safe ambulation and prevents falling, as vest supports patients at the rib cage level. Use during raising, standing, walking, and balance training.

- Use during activities of daily living, including toileting, advancing mobility, and safe ambulation
- Consider any respiratory restrictions, incisions, or chest tube placement that may be problematic due to the location of the vest
- Use **LiftPants** if patients have respiratory compromise or thoracic incision



LIKO LIFTPANTS

Model: 92 SIZES:

M – 50 kg - 85 kg

L – 70 kg - 120 kg

XL – >100 kg

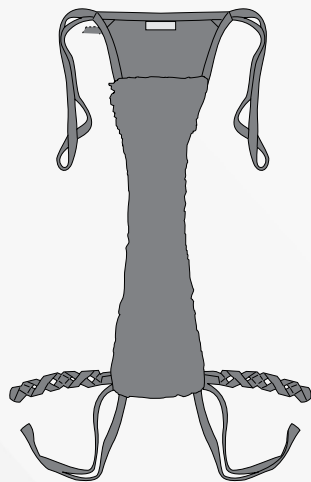

MODEL 92

Small - LSS394340
Medium - LSS394350
Large - LSS394360
XLarge - LSS394370
XXLarge - LSS394380
XXXLarge - LSS394390



FEATURES

- Durable net polyester fabric
- Latex free
- Loop straps provide additional fitting adjustment around the abdomen
- Synthetic sheepskin lining in perineal area for added comfort

CLINICAL APPLICATIONS AND CONSIDERATIONS

LiftPants allow the caregiver to provide a sense of security for patients as well as safety to prevent falls.

- Designed for patients who can bear some weight
- Safe for raising, standing, walking, and balance training
- Use during activities of daily living, including toileting, advancing mobility, and safe ambulation.
LiftPants are intended to support patients in an upright/standing position, thereby preventing a patient fall
- Not intended to “lift” patients up; patients must have weight-bearing ability and be able to stand



LIKO ULTRA LIFTPANTS

Model: 920 SIZES:

XXL – 200 kg - 500 kg

XXXL – >500 kg

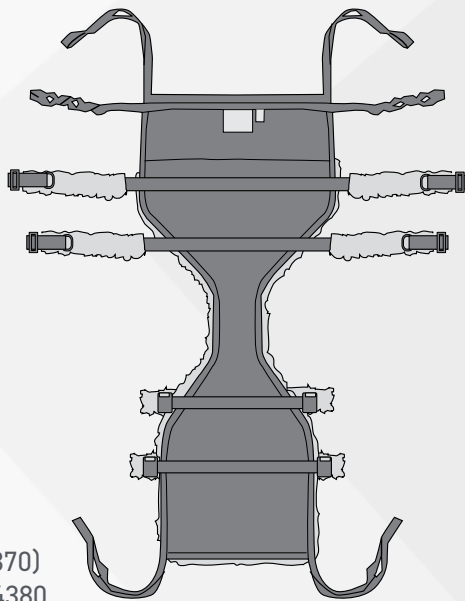

MODEL 25

XL - LSS394370)

XXL - LSS394380

XXXL - LSS394390



FEATURES

- Durable net polyester fabric
- Latex free
- Belted straps provide additional fitting adjustment around the abdomen
- Synthetic sheepskin lining in perineal area for added comfort
- Designed for bariatric patients who can bear some weight

CLINICAL APPLICATIONS AND CONSIDERATIONS

Ultra LiftPants allow the caregiver to provide a sense of security for patients as well as safety to prevent falls.

- Safe for raising, standing, walking, and balance training
- Use during activities of daily living, including toileting, advancing mobility, and safe ambulation. **Ultra LiftPants** provide a sense of security for bariatric patients as well as safety to prevent falls
- **Ultra LiftPants** are intended to support patients in an upright/standing/walking position, thereby preventing a patient fall
- Not intended to "lift" patients up; patients must have weight-bearing ability and be able to stand

LIKO SUPPORTVEST

for **Sabina** sit-to-stand lift

Models: 91/92 SIZES (VEST WIDTH) :

M – 90 cm L – 105 cm XL – 120 cm

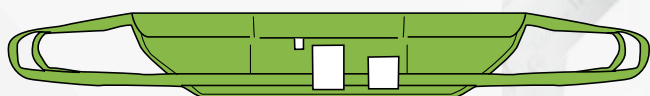

MODEL 91

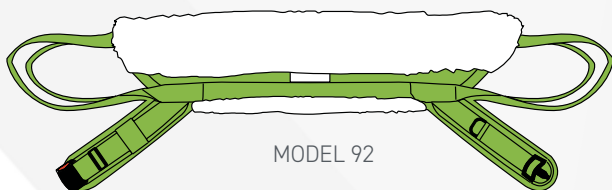

MODEL 92

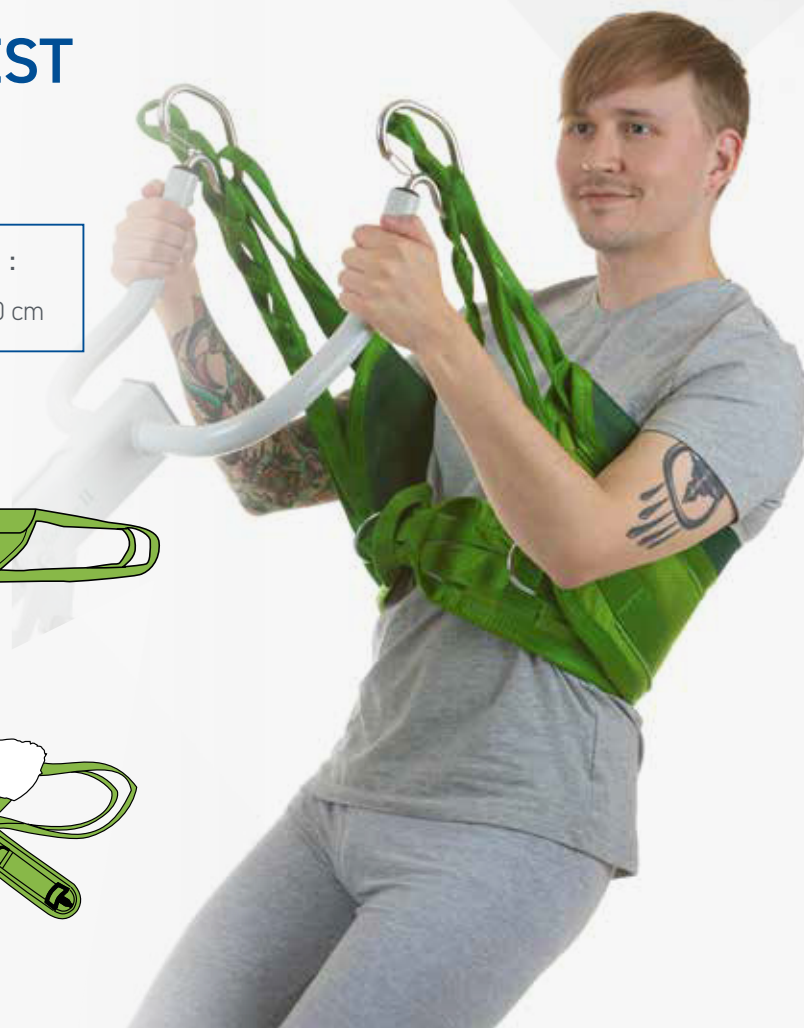

Small - LSS394120
Medium - LSS394130
Large - LSS394140
XLarge - LSS394150

FEATURES

- Durable polyester fabric
- Latex free
- Corduroy fabric in outer shell adds comfort and prevents slipping
- Synthetic sheepskin lining option available for comfort
- For use with the **Sabina**® sit-to-stand lift only

CLINICAL APPLICATIONS AND CONSIDERATIONS

- Use for transfer to chair/toilet or standing training
- Provides good support for patients as they begin weight-bearing and balance-training exercises
- Patients must have some weight-bearing ability in at least one leg
- Must be able to follow simple instructions and have some upper body strength



LIKO SAFETYVEST

for **Sabina** sit-to-stand lift

Models: 93/94 SIZES (VEST WIDTH) :

M - 90 cm L - 105 cm

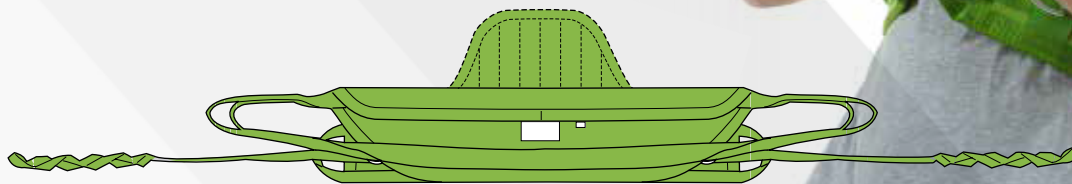

MODEL 94

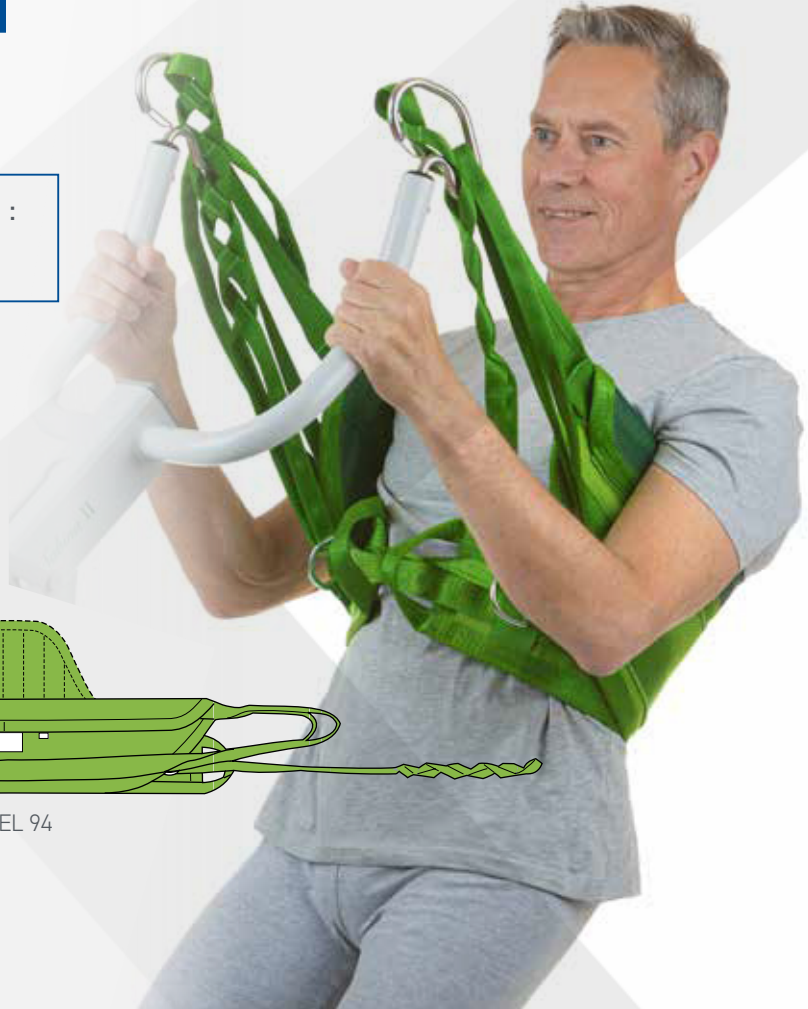

Medium - LSS394160

Large - LSS394170

FEATURES

- Durable polyester fabric
- Latex free
- A safety belt and D ring attachment safely secure patients in the vest
- For use with the **Sabina**® sit-to-stand lift only

CLINICAL APPLICATIONS AND CONSIDERATIONS

- Provides added security for patients who may be more unpredictable in their ability to raise themselves
- For bed to/from chair/toilet transfers
- Provides good support for patients as they begin weight-bearing and balance-training exercises
- Patients must have some weight-bearing ability in at least one leg
- Must be able to follow simple instructions, and have some upper body strength.
- Not recommended for respiratory-compromised patients due to thoracic pressure from the safety strap during raising

LIKO COMFORTVEST

for **Sabina** sit-to-stand lift

Model: 95 SIZES:

S - <60 kg

M - 50 kg - 80 kg

L - 70 kg - 100 kg

XL - >100 kg

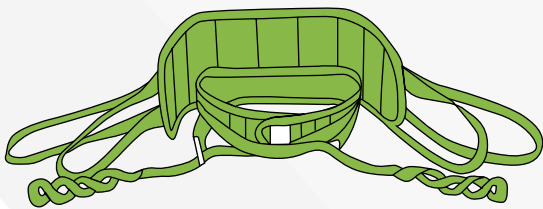

Small - LSS394180
Medium - LSS394190
Large - LSS394200
XLarge - LSS394210

FEATURES

- Durable polyester fabric
- Latex free
- Corduroy fabric in outer shell adds comfort and prevents slipping
- For use with the **Sabina**® sit-to-stand lift only

CLINICAL APPLICATIONS AND CONSIDERATIONS

- Provides added support in the event of a painful shoulder, flaccid upper extremity or other circumstances when gentle pressure in the armpit is not tolerated
- For bed to/from chair/toilet transfers
- Provides good support for patients as they begin weight-bearing and balance-training exercises
- Patients must have some weight-bearing ability in at least one leg
- Patients must be able to follow simple instructions and have some upper body strength
- An excellent choice for stroke patients



LIKO HYGIENEVEST

Models: 50/55 SIZES:

S – 30 kg - 60 kg	M – 50 kg - 80 kg	L – 70 kg - 100 kg
XL – 90 kg - 130 kg	XXL – > 130 kg	XXXL – >150 kg*

*XL, XXL, and XXXL available in Model 50 only

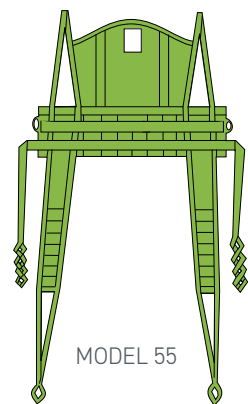
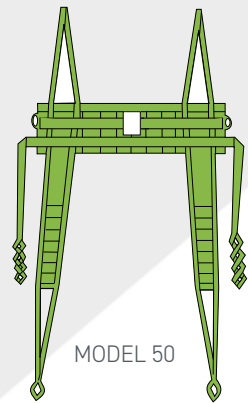

Small - LSS394220
 Medium - LSS394230
 Large - LSS394240
 XLarge - LSS394250

FEATURES

- Durable polyester fabric
- Model 55 provides additional head support
- Latex free

CLINICAL APPLICATIONS AND CONSIDERATIONS

- Provides easy access for toileting and hygiene
- Enables easy access for dressing and undressing
- Supports the upper body and provides an upright sitting posture
- Seated slings may be used for transfers to/from bed to chair/commode
- More appropriate for patients with high/low tonus and spasticity

LIKO MULTISTRAP

SIZES

Standard – 10 cm wide **Wide** – 25 cm wide

Ultra – 40 cm wide



10cm - LSS395300

25cm - LSS395310

40cm - LSS395320



FEATURES

- Durable polyester fabric or nonwoven polypropylene for single patient use
- Standard (10 cm); maximum load: 200 kg
- Wide (25 cm); maximum load: 200 kg
- Ultra (40 cm); maximum load: 200 kg in polyester only
- Single patient use is 5/10/25 cm; maximum load: 200 kg in non-woven polypropylene

CLINICAL APPLICATIONS AND CONSIDERATIONS

- Use for lifting and holding limbs during wound care/dressing changes and hygiene procedures
- Supports legs for catheterisation and bed pan placement
- Use for turning in bed and lifting or holding extremities and pannus for hygiene purposes

Baxter

Exclusively distributed by
 **aidacare**
HEALTHCARE EQUIPMENT

1300 133 120 | aidacare.com.au

ABR143.1 | 170924